

Wall-mounted boards single surface

Smit Visual single surface boards are constructed with robust materials and a thick solid core. They rightly carry the stamp 'Premium Dutch Quality'. We produce single surface boards of up to 4 meters long!



Softline 8 mm

The most popular board frame in our collection. This frame is available as standard in classic aluminium and modern black.

All colours are available on request. Softline 8 mm boards are supplied with a pen tray in the same colour as the frame.



Softline 8 mm projection board

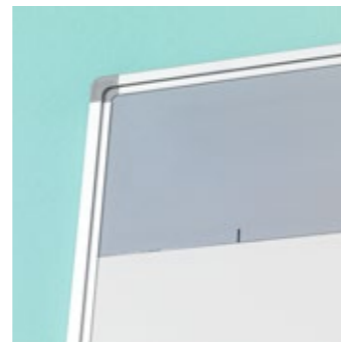



Projection ratio/ size	Dimensions	Article number
16:10 / 16:9, 100"	150 x 240 cm	11103.343
16:9, 94"	126 x 231 cm	11103.380
16:10, 83"	128 x 201 cm	11103.357

Softline 8mm projection board, Low Gloss, finger touch

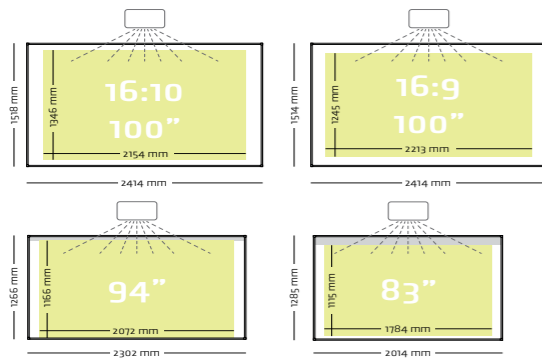

- Projection surface of Low Gloss enamelled steel fused at 800°C
- Suitable for short-throw / ultra short-throw interactive finger-touch projectors such as Epson EB-695Wi, EB-1485Fi or EB-770Fi
- Available in various projection ratios and sizes
- 94" and 83" projection boards, including grey strip for touch sensor
- Suitable for very intensive and long-term use
- Anodised aluminium frame with plastic corner pieces
- Includes mounting materials and 30 cm pen tray
- Magnetic, dry wipe



 Made of wood from responsibly managed forests

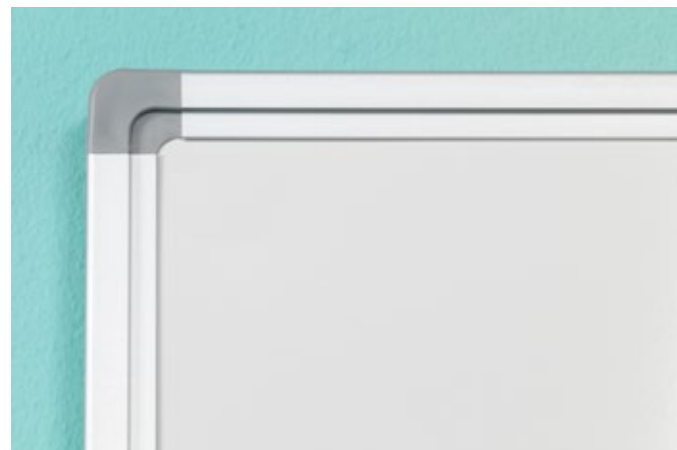

Projection ratio/ size	Dimensions	Article number
16:10 / 16:9 (100")	150 x 240 cm	11103.343
4:3	150 x 200 cm	11103.341
1:1	150 x 150 cm	11103.340
5:2	120 x 300 cm	11103.339
2:1	120 x 240 cm	11103.330
16:9 (95")	120 x 214 cm	11103.335
	120 x 200 cm	11103.338
16:10 (88")	120 x 192 cm	11103.346
4:3	120 x 160 cm	11103.331

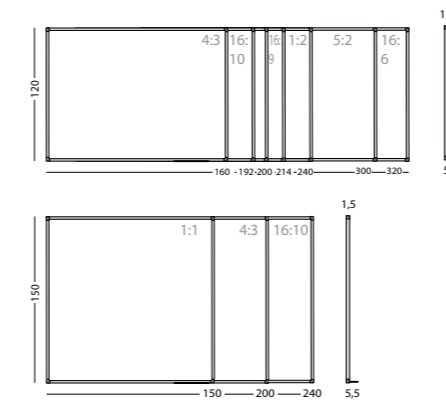

Softline 8mm projection board,
Low Gloss



- Projection surface of Low Gloss enamelled steel fused at 800°C
- Suitable for short-throw / ultra short-throw (interactive pen) projectors such as Epson EB-685Wi, EB-1480Fi or EB-760Wi
- Available in various projection ratios and sizes.
- Suitable for very intensive and long-term use
- Anodised aluminium frame with plastic corner pieces
- Includes mounting materials and 30 cm pen tray
- Magnetic, dry wipe

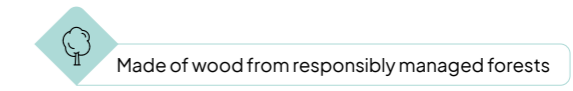

Projection ratio	Dimensions	Article number
16:9	150 x 267 cm	11103.362
16:10	150 x 240 cm	11103.361
4:3	150 x 200 cm	11103.360
1:1	150 x 150 cm	11103.363
16:9	120 x 214 cm	11103.367
16:10	120 x 192 cm	11103.366
4:3	120 x 160 cm	11103.365

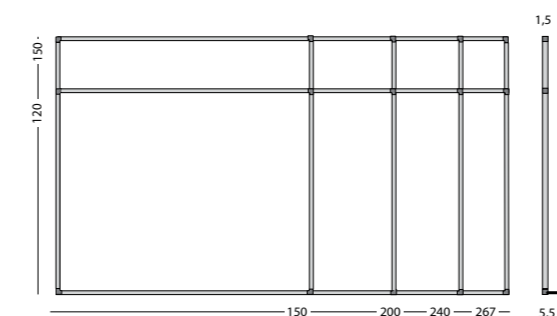

Softline 8mm projection board,
Projection steel



- Projection surface of Projection enamelled steel fused at 800°C
- The surface has the ideal properties for long-throw projection: perfect projection without a hot spot and a wide viewing angle, gloss level: 13 GU (60°)
- Available in various projection ratios and sizes.
- Suitable for very intensive and long-term use
- Anodised aluminium frame with plastic corner pieces
- Includes mounting materials and 30 cm pen tray
- Magnetic, wet wipe

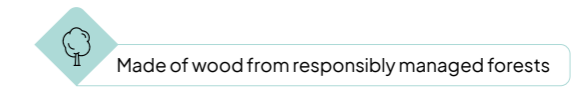

A close-up photograph of the corner of a blackboard frame. The frame is made of a light grey or silver aluminium profile. A dark green chalkboard surface is visible in the upper left. The frame is mounted to a light blue wall. Two screws are visible: one on the vertical part of the frame and one on the horizontal part. The lighting is soft, highlighting the texture of the aluminium and the smooth surface of the chalkboard.

Blackboard Softline 19 mm

The Softline 19 mm aluminium profile (SL19) is much used in schools. The frame can be combined with a lightweight core, allowing mounting on height-adjustable structures such as columns. SL19 boards are supplied as standard with a pen/chalk tray along the entire width of the board.

Projection boards ExtraFlat

The ExtraFlat profile is much used in schools. The frame can be combined with a lightweight core, allowing mounting on height-adjustable structures such as columns. ExtraFlat boards are supplied as standard with a pen/chalk tray along the entire width of the board.





ExtraFlat projection board

Wall-mounted boards,
single surface

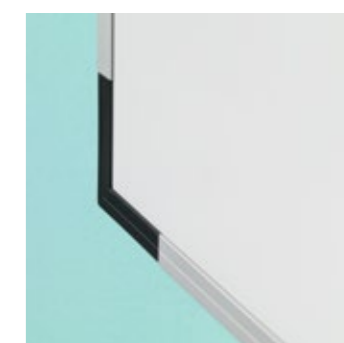

Projection ratio/
size
16:10, 16:9, 100"

Dimensions
150 x 240 cm

Article number
17106.106

Aluminium pen tray, 31 cm (optional):

18400.040

16:10

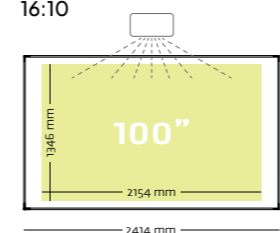

16:9

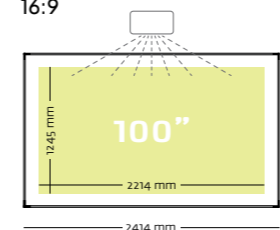

ExtraFlat Projection Board, Low Gloss, finger touch,
16:10, 16:9 - 100"



- Projection surface of Low Gloss enamelled steel fused at 800°C
- Suitable for short-throw / ultra short-throw interactive finger-touch projectors such as Epson EB-695Wi, EB-770Fi (16:10) Epson EB-1485Fi or EB-770Fi (16:9)
- Suitable for very intensive and long-term use
- Anodised aluminium frame with plastic corner pieces
- Mounting materials included
- Magnetic, dry wipe



Made of wood from responsibly managed forests



Projection ratio/ size	Dimensions	Article number
16:10, 88"	120 x 192 cm	17106.100
16:10, 100"	150 x 240 cm	17106.106
Aluminium pen tray, 31 cm (optional):		18400.040

ExtraFlat Projection Board, Low Gloss,
16:10



- Projection surface of Low Gloss enamelled steel fused at 800°C
- Suitable for short-throw / ultra short-throw (interactive pen) projectors (16:10) such as Epson EB-685Wi, EB-1480Fi or EB-760Wi
- Suitable for very intensive and long-term use
- Anodised aluminium frame with plastic corner pieces
- Mounting materials included
- Magnetic, dry wipe

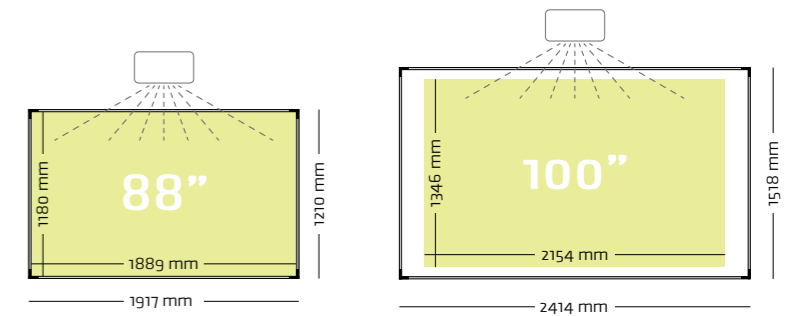

Made of wood from responsibly managed forests

Projection ratio/ size	Dimensions	Article number
16:9, 95"	120 x 214 cm	17106.115
Aluminium pen tray, 31 cm (optional):		18400.040

ExtraFlat Projection Board, Low Gloss,
16:9



- Projection surface of Low Gloss enamelled steel fused at 800°C
- Suitable for short-throw / ultra short-throw (interactive pen) projectors (16:9) such as Epson EB-685Wi, EB-1480Fi or EB-760Wi
- 94" projection board, including grey strip for touch sensor
- Suitable for very intensive and long-term use
- Anodised aluminium frame with plastic corner pieces
- Mounting materials included
- Magnetic, dry wipe

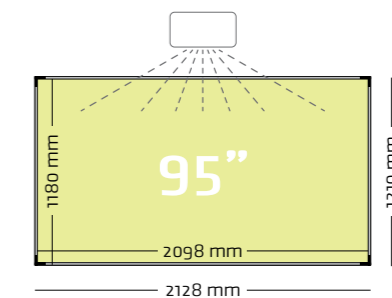

Made of wood from responsibly managed forests

Projection boards ExtraFlat

Winged projection boards are lightweight, allowing them to be mounted on columns (see from page 100).

These boards can have recesses in them for touch sensor modules. The wings can then still be folded away completely. The grey strip on the board is the area where the module can be installed.



Projection ratio/
size
16:10, 83"

Dimensions
128 x 201 cm

Article number
17106.201

Aluminium pen tray, 31 cm (optional):
18400.040

ExtraFlat Projection Board, Low Gloss,
finger touch, 16:10



- Projection surface of Low Gloss enamelled steel fused at 800°C
- The board has two wings with a double-sided writing surface of white enamelled steel fused at 800°C
- Suitable for short-throw / ultra short-throw interactive finger-touch projectors (16:10) such as Epson EB-695Wi
- Includes grey strip for touch sensor
- Suitable for very intensive and long-term use
- Anodised aluminium frame with plastic corner pieces
- Mounting materials included
- Magnetic, dry wipe

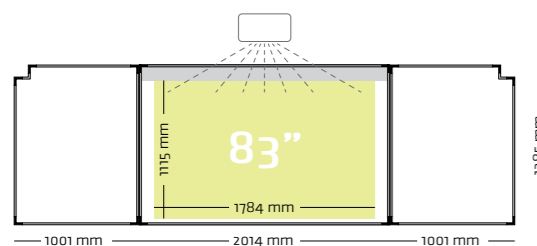

Made of wood from responsibly managed forests



Projection ratio/
size
16:9, 94"

Dimensions
126 x 231 cm

Article number
17106.208

Aluminium pen tray, 31 cm (optional):
18400.040

ExtraFlat Projection Board, Low Gloss,
finger touch, 16:9



- Projection surface of Low Gloss enamelled steel fused at 800°C
- The board has two wings with a double-sided writing surface of white enamelled steel fused at 800°C
- Suitable for short-throw / ultra short-throw interactive finger-touch projectors (16:9) such as Epson EB-1485Fi or EB-770Fi
- Includes grey strip for touch sensor
- Suitable for very intensive and long-term use
- Anodised aluminium frame with plastic corner pieces
- Mounting materials included
- Magnetic, dry wipe

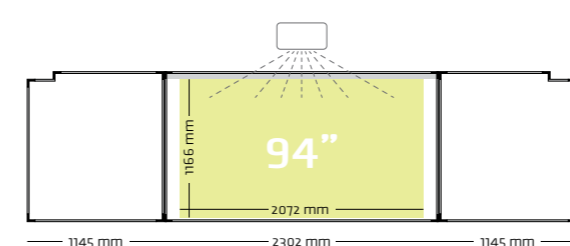

Made of wood from responsibly managed forests

Wall-mounted boards height- adjustable

The height-adjustable writing boards can easily be changed or moved. Each suspension system has its own benefits and attributes, but they all provide flexibility of use.



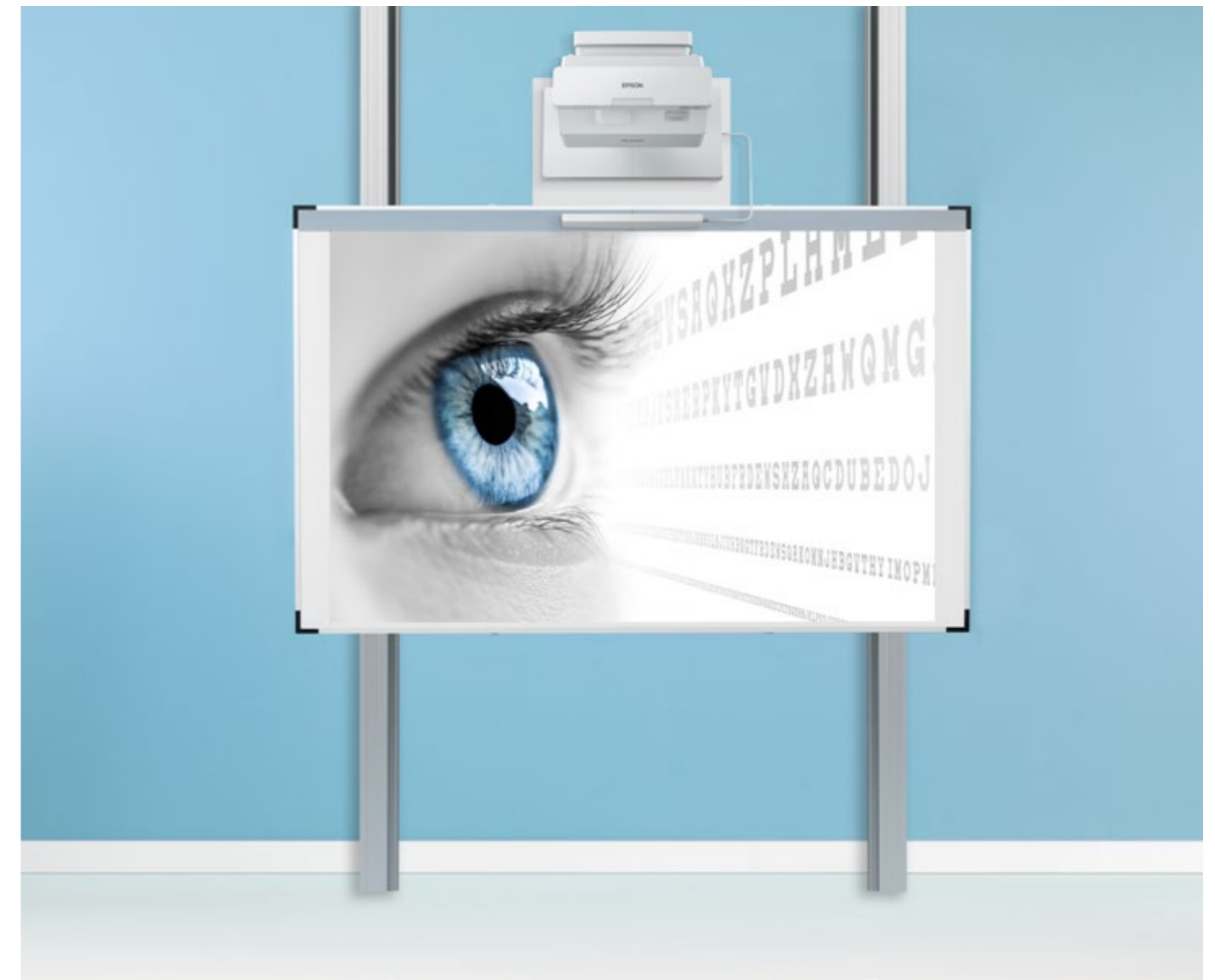

Projection ratio/ size	Dimensions	Article number
16:10, 83"	128 x 201 cm	18310.401
16:10, 100"	150 x 240 cm	18310.423

ExtraFlat Projection Board, Low Gloss, finger touch, 16:10



- Projection surface of Low Gloss enamelled steel fused at 800°C
- Suitable for short-throw / ultra short-throw interactive finger-touch projectors (16:10) such as Epson EB-695Wi or EB-770Fi
- 83" board, including grey strip for touch sensor
- Mounted between two columns, standard height: 290 cm. Taller columns optional
- Infinitely adjustable height
- Suitable for very intensive and long-term use
- Anodised aluminium frame with plastic corner pieces
- Includes mounting materials and two 31 cm aluminium pen trays
- Magnetic, dry wipe

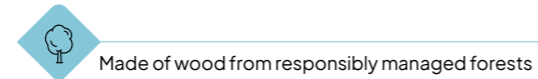
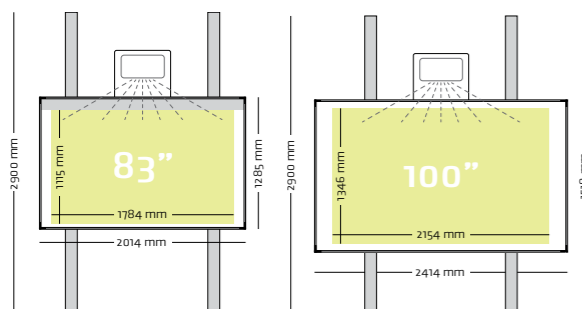

Projection ratio/ size	Dimensions	Article number
16:9, 94"	126 x 231 cm	18310.422
16:9, 100"	150 x 240 cm	18310.423

ExtraFlat Projection Board, Low Gloss, finger touch, 16:9



- Projection surface of Low Gloss enamelled steel fused at 800°C
- Suitable for short-throw / ultra short-throw interactive finger-touch projectors (16:9) such as Epson EB-1485Fi or EB-770Fi
- 94" board, including grey strip for touch sensor
- Mounted between two columns, standard height: 290 cm. Taller columns optional
- Infinitely adjustable height
- Suitable for very intensive and long-term use
- Anodised aluminium frame with plastic corner pieces
- Includes mounting materials and two 31 cm aluminium pen trays
- Magnetic, dry wipe

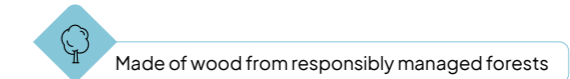
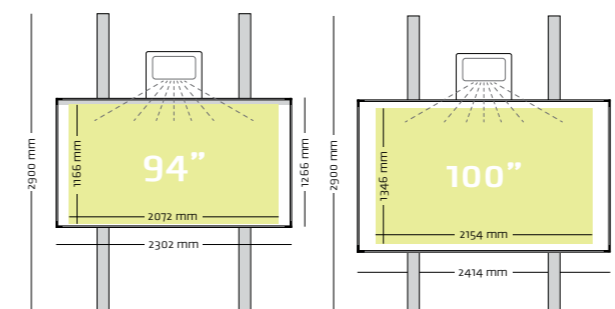



Projection ratio/
size
16:10, 88"
16:10, 100"

Dimensions
120 x 192 cm
150 x 240 cm

Article number
18310.102
18310.423

ExtraFlat Projection Board, Low Gloss, 16:10



- Projection surface of Low Gloss enamelled steel fused at 800°C
- Suitable for short-throw / ultra short-throw (interactive pen) projectors (16:10) such as Epson EB-685Wi, EB-1480Fi or EB-760Wi
- Mounted between two columns, standard height: 290 cm. Taller columns optional
- Infinitely adjustable height
- Suitable for very intensive and long-term use
- Anodised aluminium frame with plastic corner pieces
- Includes mounting materials and two 31 cm aluminium pen trays
- Magnetic, dry wipe

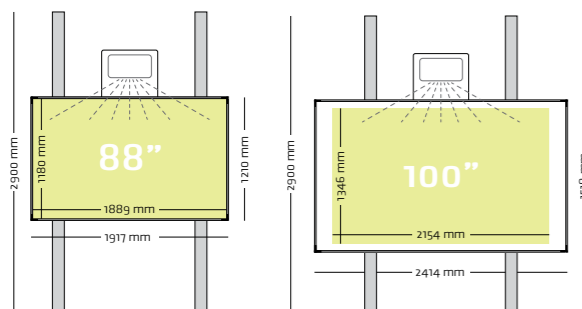

Made of wood from responsibly managed forests



Projection ratio/
size
16:9, 95"

Dimensions
120x214 cm

Article number
18310.122

ExtraFlat Projection Board, Low Gloss, 16:9



- Projection surface of Low Gloss enamelled steel fused at 800°C
- Suitable for short-throw / ultra short-throw (interactive pen) projectors (16:9) such as Epson EB-1480Fi or EB-760Wi
- Mounted between two columns, standard height: 290 cm. Taller columns optional
- Infinitely adjustable height
- Suitable for very intensive and long-term use
- Anodised aluminium frame with plastic corner pieces
- Includes mounting materials and two 31 cm aluminium pen trays
- Magnetic, dry wipe

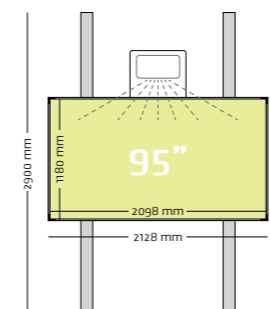

Made of wood from responsibly managed forests



Winged columns

Our column boards are made of extremely solid materials, which makes them suitable for long-term intensive use. Furthermore, thanks to the counterweight construction, the height can easily be adjusted.



Projection ratio/
size
16:10, 83"

Dimensions
128 x 201 cm

Article number
18310.411

Winged ExtraFlat Projection Board, Low Gloss,
finger touch, 16:10



- Projection surface of Low Gloss enamelled steel fused at 800°C
- The board has two wings with a double-sided writing surface of white enamelled steel fused at 800°C
- Suitable for short-throw / ultra short-throw interactive finger-touch projectors (16:10) such as Epson EB-695Wi or EB-770Fi
- Includes grey strip for touch sensor
- Mounted between two columns, standard height: 290 cm. Taller columns optional
- Infinitely adjustable height
- Suitable for very intensive and long-term use
- Anodised aluminium frame with plastic corner pieces
- Includes mounting materials and two 31 cm aluminium pen trays
- Magnetic, dry wipe

Made of wood from responsibly managed forests

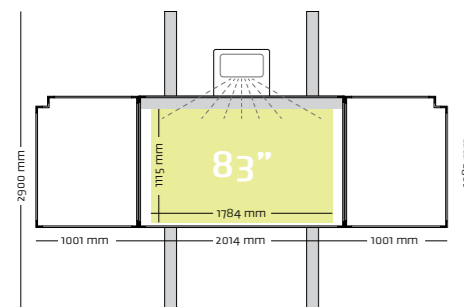

Projection ratio/
size
16:9, 94"

Dimensions
126 x 231 cm

Article number
18310.421

Winged ExtraFlat Projection Board, Low Gloss,
finger touch, 16:9



- Projection surface of Low Gloss enamelled steel fused at 800°C
- The board has two wings with a double-sided writing surface of white enamelled steel, fused at 800°C
- Suitable for short-throw / ultra short-throw interactive finger-touch projectors (16:9) such as Epson EB-1485Fi or EB-770Fi
- Includes grey strip for touch sensor
- Mounted between two columns, standard height: 290 cm. Taller columns optional
- Infinitely adjustable height
- Suitable for very intensive and long-term use
- Anodised aluminium frame with plastic corner pieces
- Includes mounting materials and two 31 cm aluminium pen trays
- Magnetic, dry wipe

Made of wood from responsibly managed forests

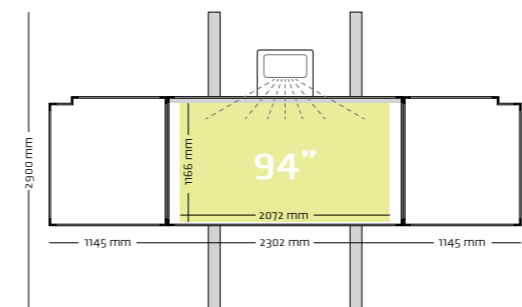



Projection ratio/
size
16:10, 88"

Dimensions
120 x 192 cm

Article number
18310.112

Winged ExtraFlat Projection Board, Low Gloss, 16:10



- Projection surface of Low Gloss enamelled steel fused at 800°C
- The board has two wings with a double-sided writing surface of white enamelled steel fused at 800°C
- Suitable for short-throw / ultra short-throw (interactive pen) projectors (16:10) such as Epson EB-685Wi, EB-1480Fi or EB-760Wi
- Mounted between two columns, standard height: 290 cm. Taller columns optional
- Infinitely adjustable height
- Suitable for very intensive and long-term use
- Anodised aluminium frame with plastic corner pieces
- Includes mounting materials and two 31 cm aluminium pen trays
- Magnetic, dry wipe



Made of wood from responsibly managed forests

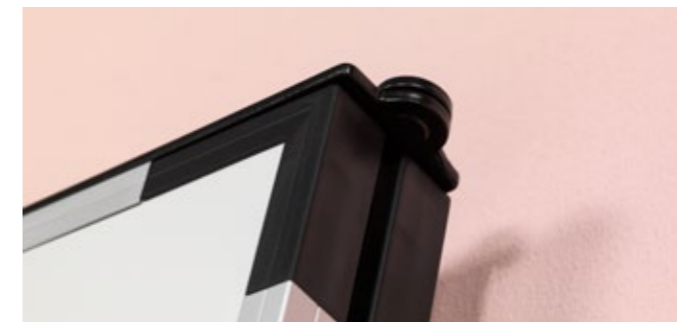
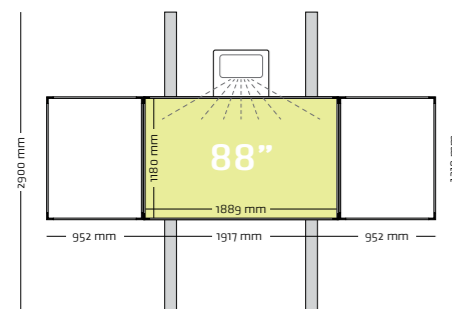

Projection ratio/
size
16:9, 95"

Dimensions
120 x 214 cm

Article number
18310.121

Winged ExtraFlat Projection Board, Low Gloss, 16:9



- Projection surface of Low Gloss enamelled steel fused at 800°C
- The board has two wings with a double-sided writing surface of white enamelled steel fused at 800°C
- Suitable for short-throw / ultra short-throw (interactive pen) projectors (16:9) such as Epson EB-1480Fi or EB-7360W
- Mounted between two columns, standard height: 290 cm. Taller columns optional
- Infinitely adjustable height
- Suitable for very intensive and long-term use
- Anodised aluminium frame with plastic corner pieces
- Includes mounting materials and two 31 cm aluminium pen trays
- Magnetic, dry wipe



Made of wood from responsibly managed forests

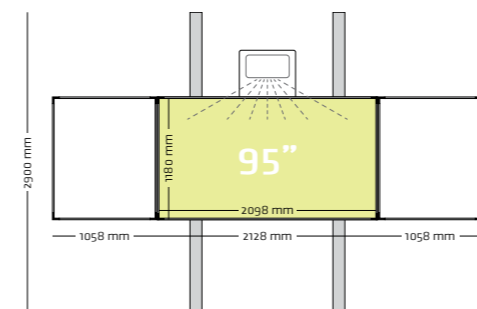

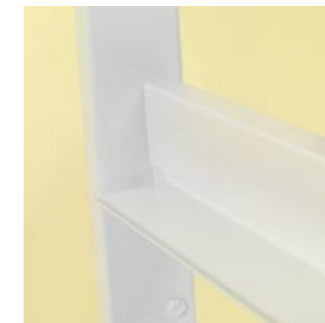
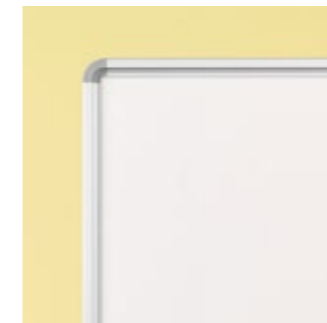

Dimensions
120 x 200 cm

Article number
13009.124

Revolving projection/enamelled steel board



- One side has a projection surface of projection enamelled steel, fused at 800°C
- One side has a writing surface of enamelled steel, fused at 800°C
- Suitable for very intensive and long-term use
- Anodised aluminium frame with plastic corner pieces
- The sturdy white base has a long pen tray and four solid industrial wheels, two of which have brakes
- The rotary knob allows the board to be turned through 360° and to be fixed at any angle
- Magnetic, dry wipe writing surface and wet wipe projection surface

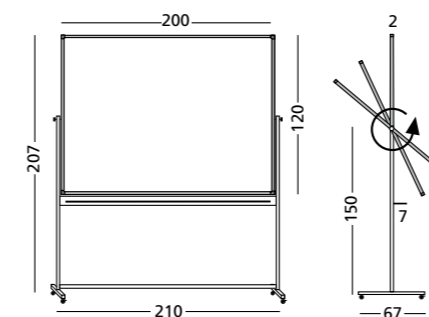

Made of wood from responsibly managed forests