

# Rail system

PartnerLine rail systems are multifunctional and the ideal solution for designing your presentation options in a flexible, versatile and entirely customisable way. The boards have a white lacquered frame with white plastic corner pieces.

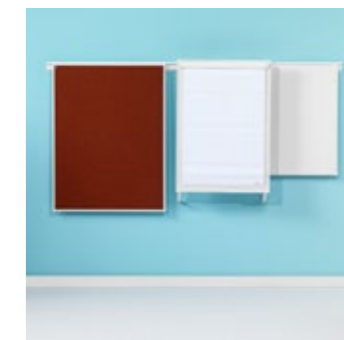

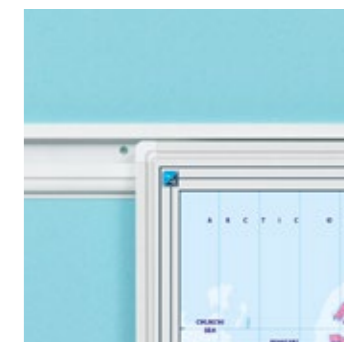
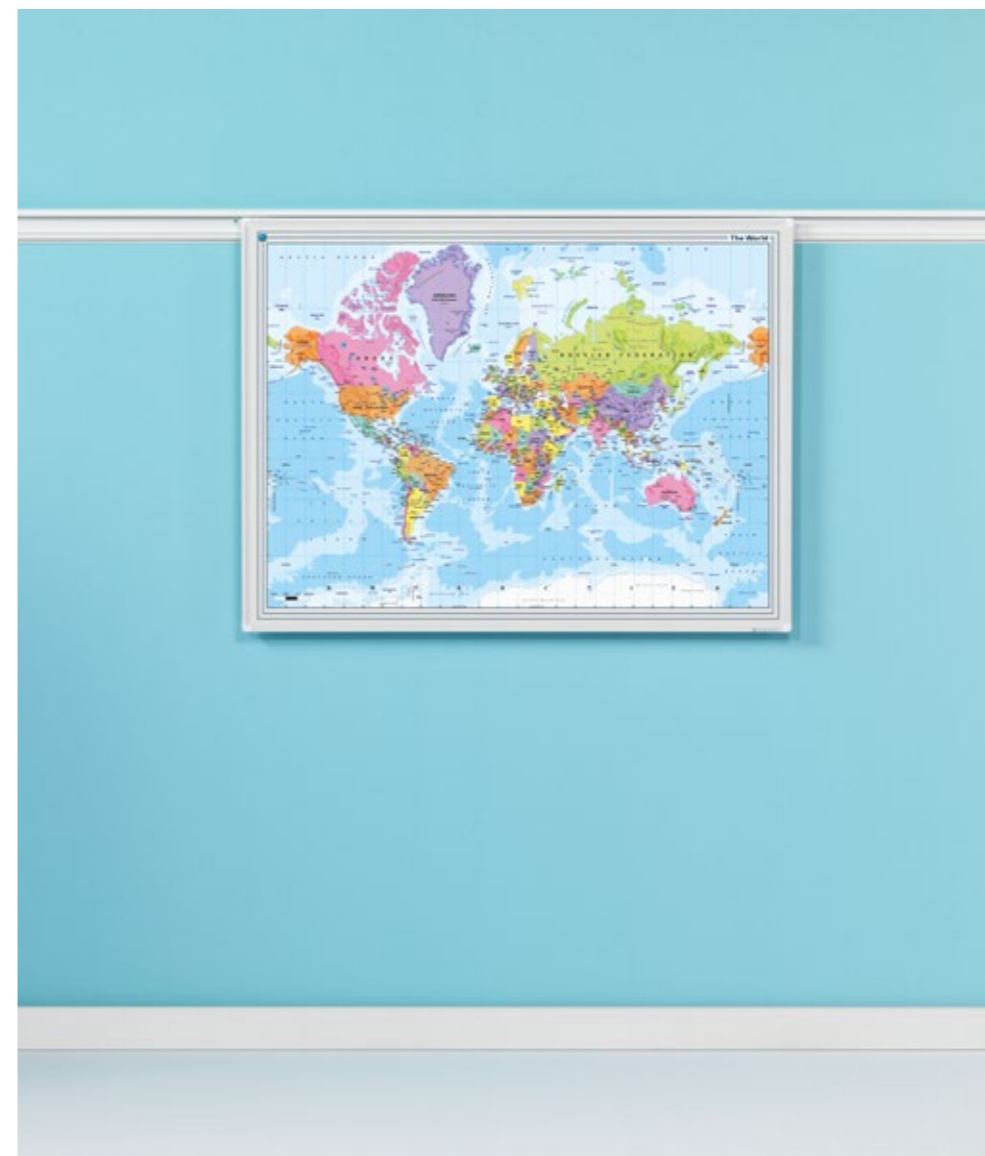
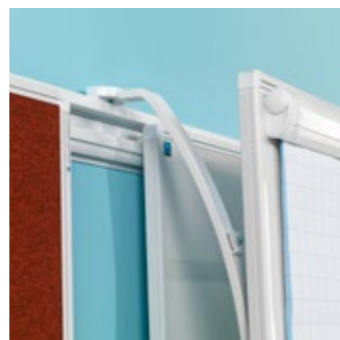
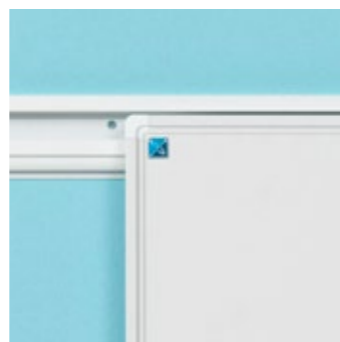

More info on  
customised  
printing?  
See page 33

PartnerLine Rail whiteboard, white enamel

- Writing surface of white enamelled steel, fused at 800°C
- Suitable for very intensive and long-term use
- Lightweight board
- White PartnerLine frame with white plastic corner pieces
- Includes 30 cm pen tray and rail mounting adapter set
- Magnetic, dry wipe
- PartnerLine Rail (p. 154 - 155) needs to be ordered separately



Dimensions	Article number
90x180 cm	11106.100
90x120 cm	11106.101
60x90 cm	11106.102

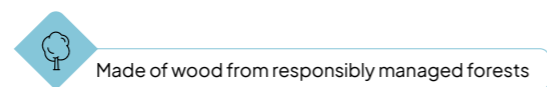
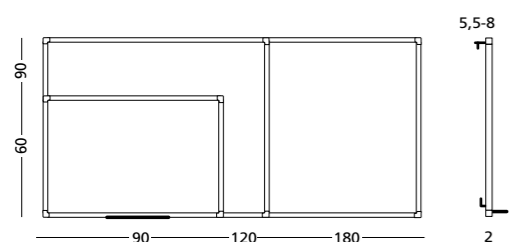

PartnerLine Rail whiteboard, maps

- Very detailed full-colour map printed on steel sublimation
- Suitable for normal to fairly intensive use
- Lightweight board
- White PartnerLine frame with white plastic corner pieces
- Includes 30 cm pen tray and rail mounting adapter set
- Magnetic, dry wipe
- PartnerLine Rail (p. 154 - 155) needs to be ordered separately



Print	Scale	Dimensions	Article number
The Netherlands, road map	1: 270,000	120 x 90 cm	11106.110
Europe, road map	1: 6,170,000	90 x 120 cm	11106.116
World, political	1: 34,232,000	90 x 120 cm	11106.117

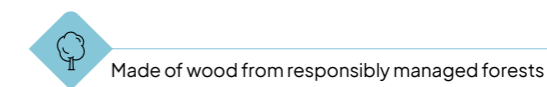
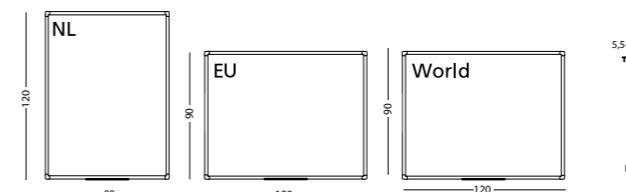

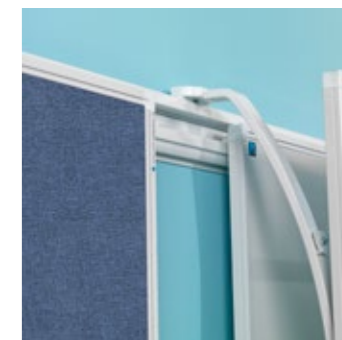
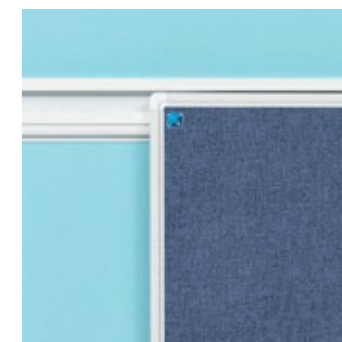
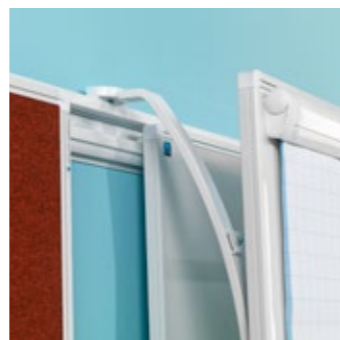
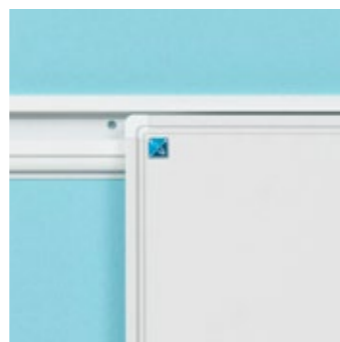
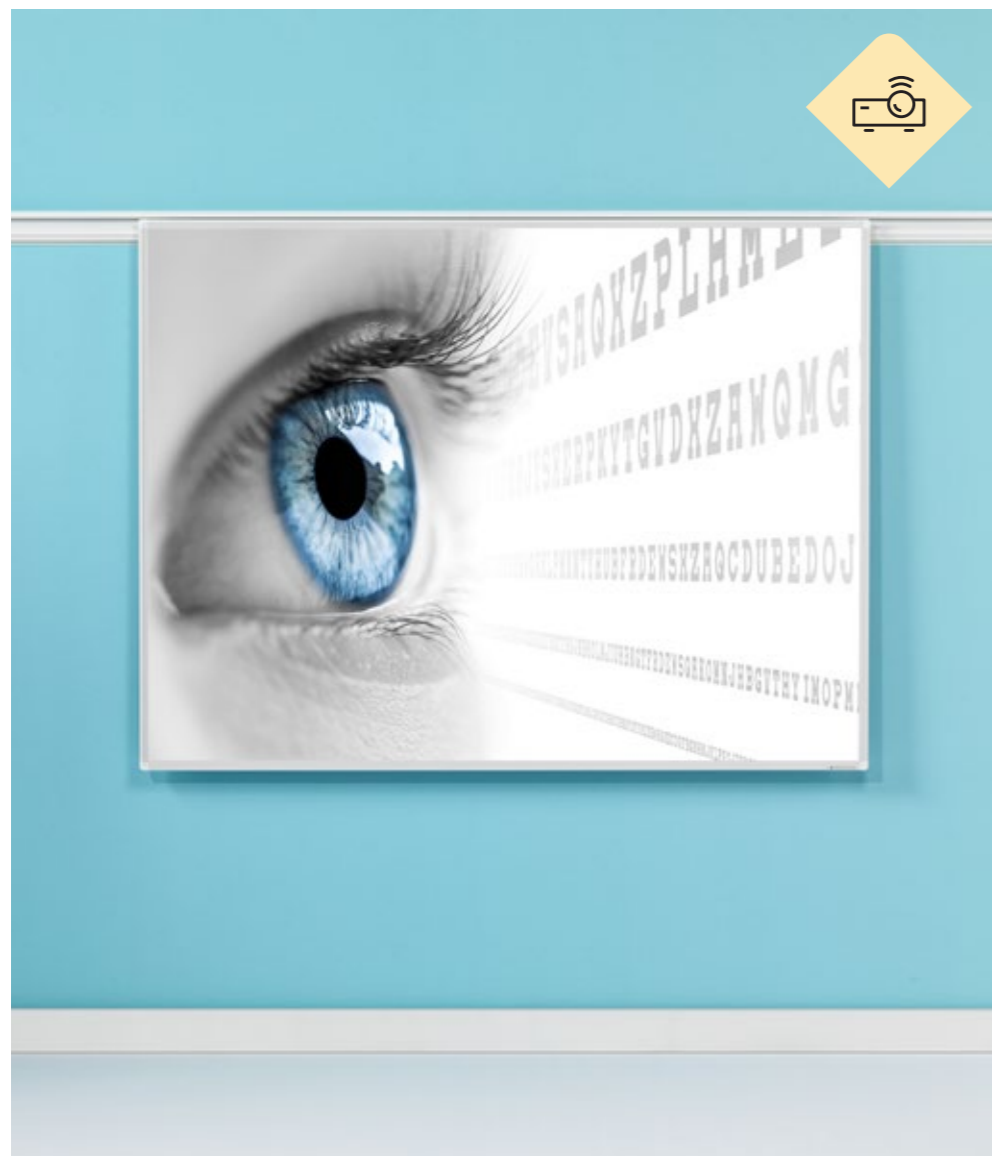

PartnerLine Rail projection board, Projection



- Projection surface of Projection enamelled steel fused at 800°C
- The surface has the ideal properties for long-throw projection: perfect projection without a hot spot and a wide viewing angle, gloss level: 13 GU (60°)
- Suitable for very intensive and long-term use
- Lightweight board
- White PartnerLine frame with white plastic corner pieces
- Includes 30 cm pen tray and rail mounting adapter set
- Magnetic, dry wipe
- PartnerLine Rail (p. 154 - 155) needs to be ordered separately



Projection ratio	Dimensions	Article number
16:10	118 x 189 cm	11106.161
16:3	118 x 157 cm	11106.160

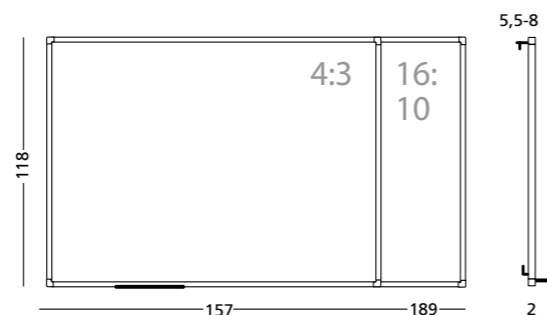

Made of wood from responsibly managed forests

PartnerLine Rail pinboard, Camira

- Pinboard surface of 100% recycled, high-quality Camira fabric
- The Camira fabric is colourfast, durable, anti-lint, flame-resistant, washable and environmentally friendly
- Suitable for very intensive and long-term use
- Lightweight board
- White PartnerLine frame with white plastic corner pieces
- Includes rail mounting adapter set
- PartnerLine Rail (p. 154 - 155) needs to be ordered separately



Surface	Dimensions	Article number
Camira Blue-Purple (AK007)	90 x 180 cm	11207.114
	90 x 120 cm	11207.113
	60 x 90 cm	11207.112
Camira Dark Grey (AK019)	90 x 180 cm	11207.117
	90 x 120 cm	11207.116
	60 x 90 cm	11207.115

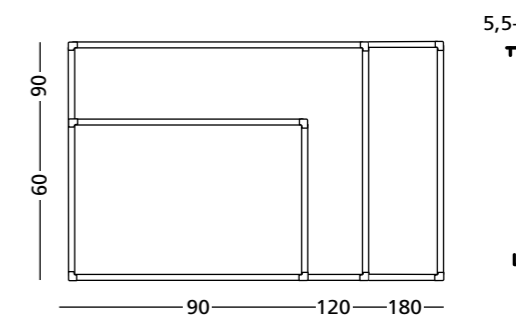

Made of wood from responsibly managed forests

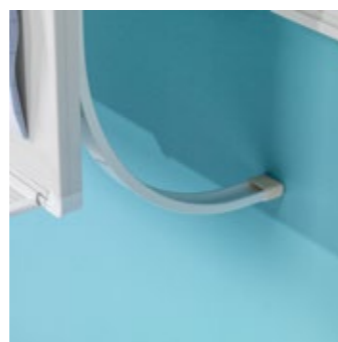
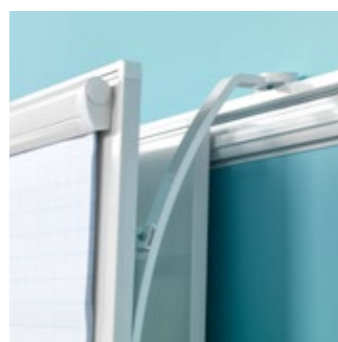

PartnerLine Rail flipchart



- Flipchart with a magnetic, dry-wipe white enamel writing surface
- With white enamel PartnerLine profile and white plastic corner pieces
- Includes adapter set and 30 cm pen tray
- The universal paper holders are suitable for various sizes of flipchart paper
- PartnerLine Rail (p. 154 - 155) needs to be ordered separately



NO LONGER AVAILABLE

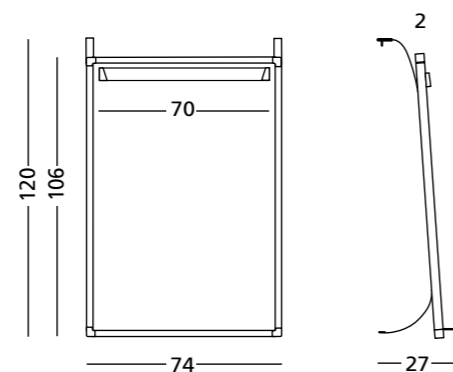

Made of wood from responsibly managed forests



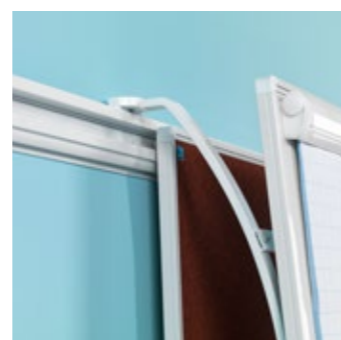

PartnerLine Rail, double



Dimensions  
240 x 8 cm

Article number  
12105.100

- Aluminium wall-rail system, white, 240 cm long, double version
- The boards can be hung at two different depths, enabling them to be slid in front or behind each other
- With paper clamp at the bottom edge, along the entire width of the rail
- Several rails can be joined together with the connecting piece
- Can be cut to size
- Can be mounted 'round the corner' using the the 90° corner piece (p. 155)
- Includes adapter set, paper clamp rollers, end caps, connecting piece, cover strip and mounting materials

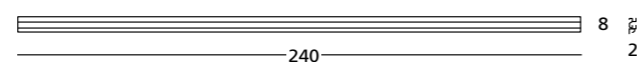

13013.101

14022.103

PartnerLine Rail, accessories



PartnerLine Rail, adapter set  
Article number  
13013.101

PartnerLine Rail, 90° corner piece  
Article number  
14022.103

- PartnerLine Rail, adapter set
- Complete set of mounting materials to hang a product in the top or bottom rail
  - Includes spacers, sliding blocks and mounting materials
  - Quick and easy to assemble

- PartnerLine Rail, 90° corner piece
- 90° corner piece for a right-angle corner joint between 2 double PartnerLine Rails

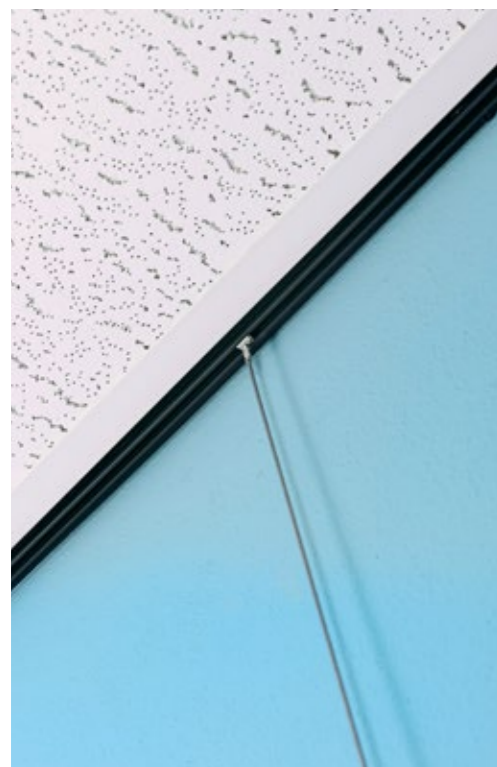

Ceiling rails



Description	Dimensions	Article number
Clip rail, ceiling mounted, white	150 x 3.5 cm	14010.102
Ceiling rail set, black	150 x 1.5 cm	14010.101

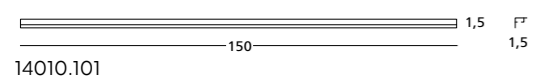
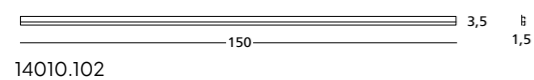

Clip Rail set, ceiling mounted, white

- White aluminium wall-mounted rail to hang small whiteboards and pictures
- With space to conceal cables
- The set consists of two 1.5 metre rails and includes suspension materials
- Excludes whiteboard and suspension cables (suspension cables: see p. 157)

Ceiling rail set, black

- Black aluminium ceiling rail to hang small whiteboards and pictures
- For mounting on the side bar of a suspended ceiling
- The set consists of two 1.5 metre rails and includes suspension materials
- Excludes whiteboard and suspension cables (suspension cables: see p. 157)



14010.110



14010.111



14010.112

Adapter sets



Description	Article number
Adapter set for whiteboards	14010.110
Adapter set for painting, Perlon	14010.111
Adapter set for painting, steel cable	14010.112

Adapter set for whiteboards

- Set for suspending whiteboards from the clip rail or ceiling rail
- In addition to two (150 cm) steel cables and two suspension hooks, the set also includes four stabilising caps to protect the wall
- Maximum board size 90 x 120 cm
- Maximum weight per hook: 15 kg

Adapter Set for Paintings, Perlon

- Set of 2 transparent Perlon cords, 150 cm long, and two hooks to hang paintings, photos and calendars to the clip rail or ceiling rail
- Maximum weight per hook: 4 kg

Adapter Set for Paintings, Steel cable

- Set of 2 steel cables, 150 cm long, and two hooks to hang paintings, photos and calendars to the clip rail or ceiling rail
- Maximum weight per hook: 15 kg