

Rail system

PartnerLine rail systems are multifunctional and the ideal solution for designing your presentation options in a flexible, versatile and entirely customisable way. The boards have a white lacquered frame with white plastic corner pieces.

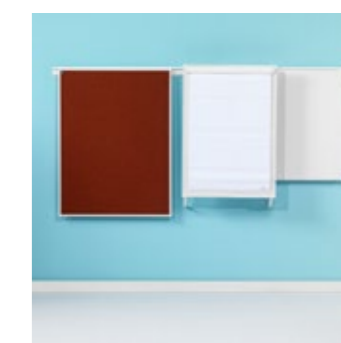

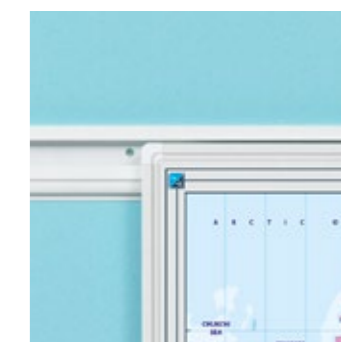
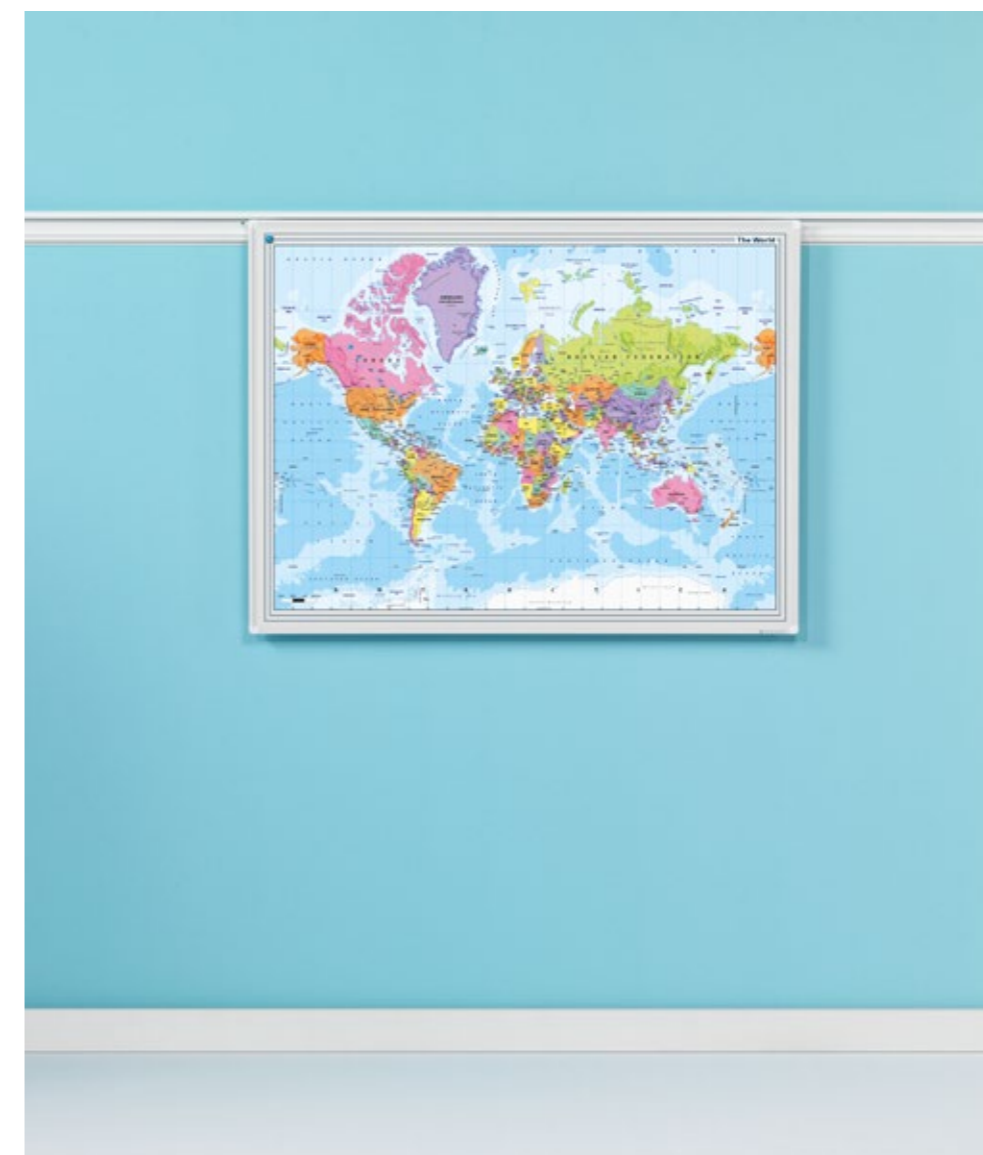
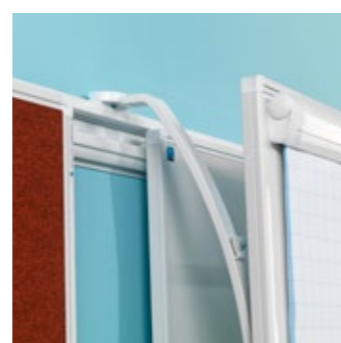

More info on
customised
printing?
See page 33

PartnerLine Rail whiteboard, white enamel

- Writing surface of white enamelled steel, fused at 800°C
- Suitable for very intensive and long-term use
- Lightweight board
- White PartnerLine frame with white plastic corner pieces
- Includes 30 cm pen tray and rail mounting adapter set
- Magnetic, dry wipe
- PartnerLine Rail (p. 148 - 149) needs to be ordered separately



Dimensions	Article number
90x180 cm	11106.100
90x120 cm	11106.101
60x90 cm	11106.102

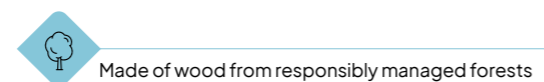
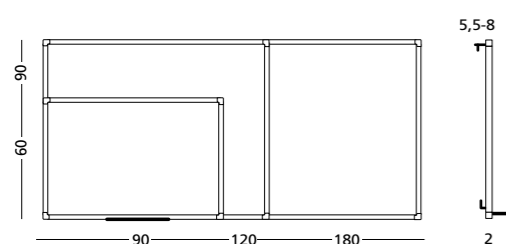

PartnerLine Rail whiteboard, maps

- Very detailed full-colour map printed on steel sublimation
- Suitable for normal to fairly intensive use
- Lightweight board
- White PartnerLine frame with white plastic corner pieces
- Includes 30 cm pen tray and rail mounting adapter set
- Magnetic, dry wipe
- PartnerLine Rail (p. 1148 - 149) needs to be ordered separately

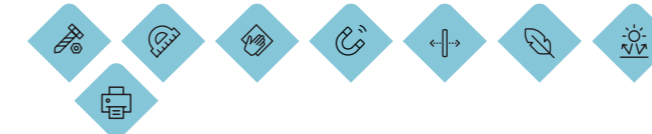

Print	Scale	Dimensions	Article number
The Netherlands, road map	1: 270,000	120 x 90 cm	11106.110
Europe, road map	1: 6,170,000	90 x 120 cm	11106.116
World, political	1: 34,232,000	90 x 120 cm	11106.117

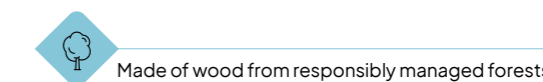
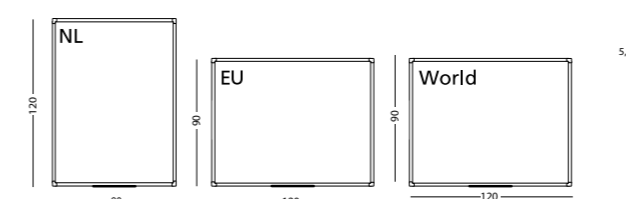

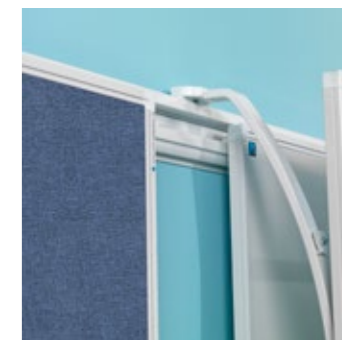
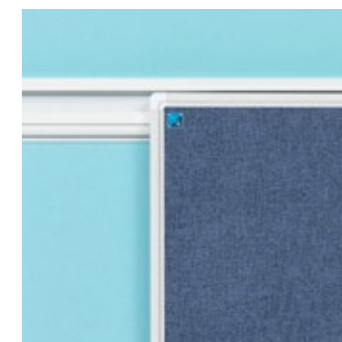
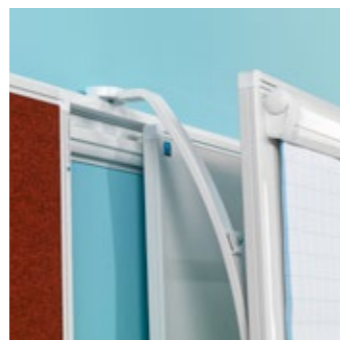
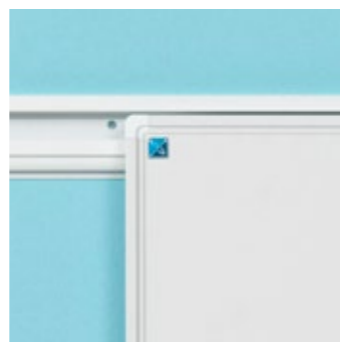
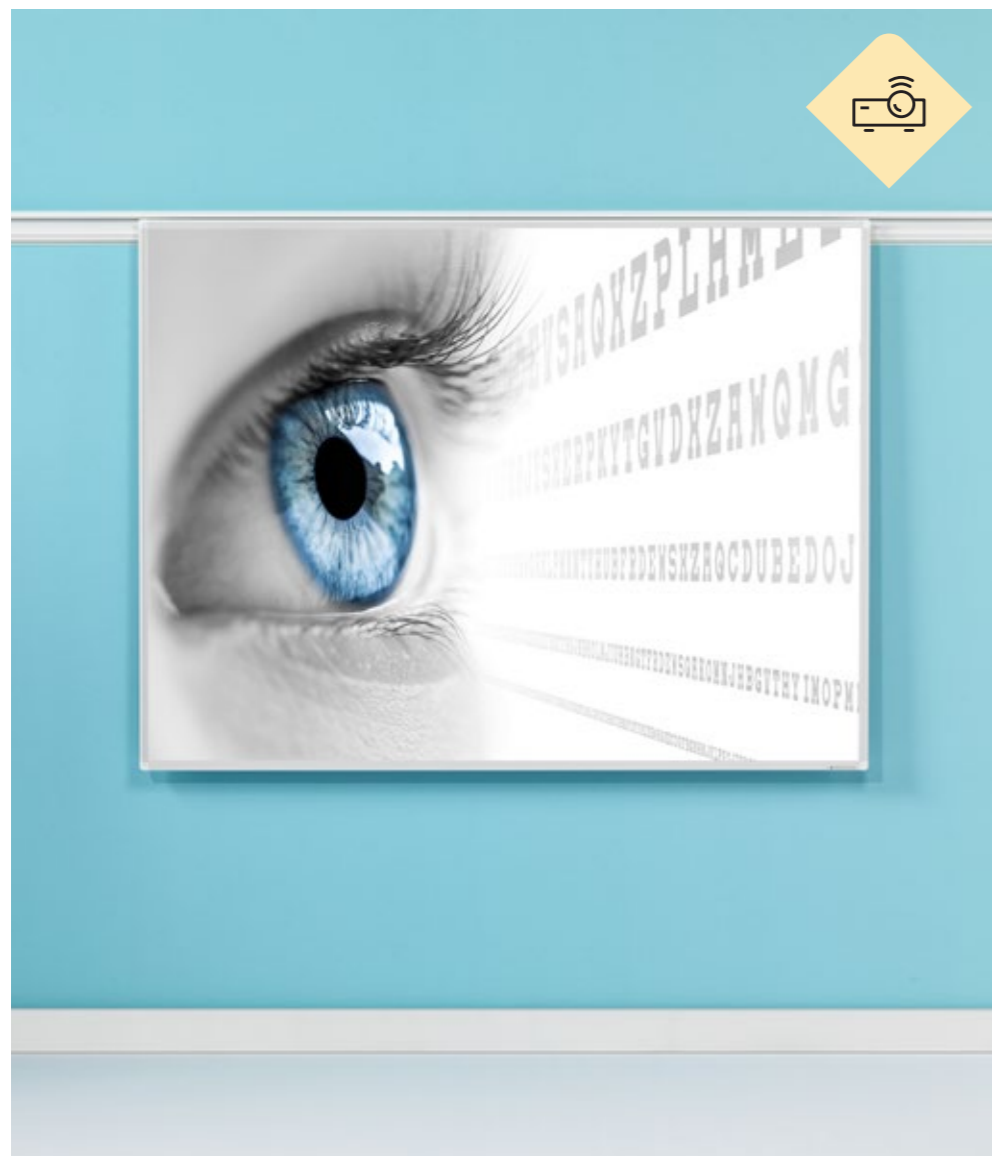

PartnerLine Rail projection board, Projection



- Projection surface of Projection enamelled steel fused at 800°C
- The surface has the ideal properties for long-throw projection: perfect projection without a hot spot and a wide viewing angle, gloss level: 13 GU (60°)
- Suitable for very intensive and long-term use
- Lightweight board
- White PartnerLine frame with white plastic corner pieces
- Includes 30 cm pen tray and rail mounting adapter set
- Magnetic, dry wipe
- PartnerLine Rail (p. 148 - 149) needs to be ordered separately



Projection ratio	Dimensions	Article number
16:10	118 x 189 cm	11106.161
16:3	118 x 157 cm	11106.160

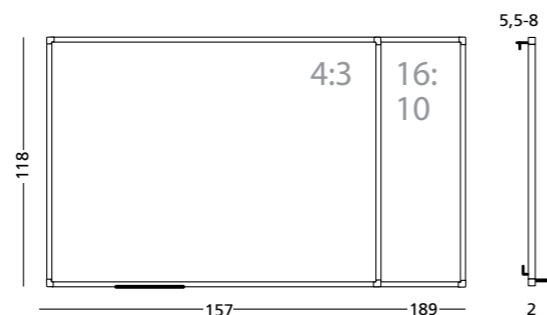

Made of wood from responsibly managed forests

PartnerLine Rail pinboard, Camira

- Pinboard surface of 100% recycled, high-quality Camira fabric
- The Camira fabric is colourfast, durable, anti-lint, flame-resistant, washable and environmentally friendly
- Suitable for very intensive and long-term use
- Lightweight board
- White PartnerLine frame with white plastic corner pieces
- Includes rail mounting adapter set
- PartnerLine Rail (p. 148 - 149) needs to be ordered separately



Surface	Dimensions	Article number
Camira Blue-Purple (AK007)	90 x 180 cm	11207.114
	90 x 120 cm	11207.113
	60 x 90 cm	11207.112
Camira Dark Grey (AK019)	90 x 180 cm	11207.117
	90 x 120 cm	11207.116
	60 x 90 cm	11207.115

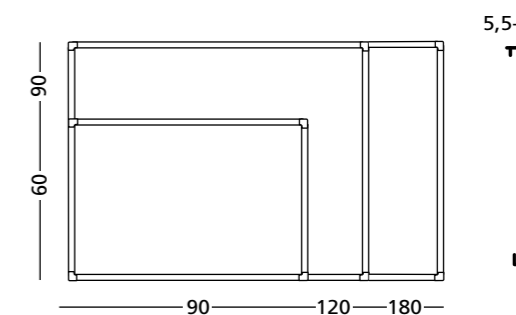

Made of wood from responsibly managed forests

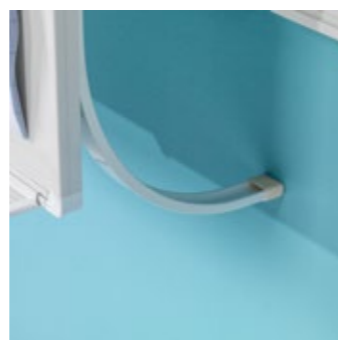
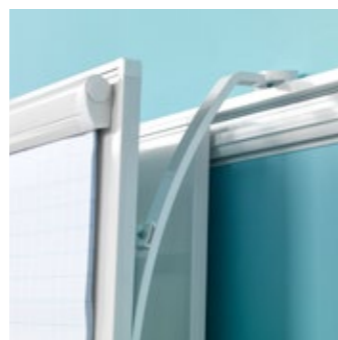

PartnerLine Rail flipchart



- Flipchart with a magnetic, dry-wipe white enamel writing surface
- With white enamel PartnerLine profile and white plastic corner pieces
- Includes adapter set and 30 cm pen tray
- The universal paper holders are suitable for various sizes of flipchart paper
- PartnerLine Rail (p. 148 - 149) needs to be ordered separately



Dimensions
100 x 70 cm

Article number
12205.101

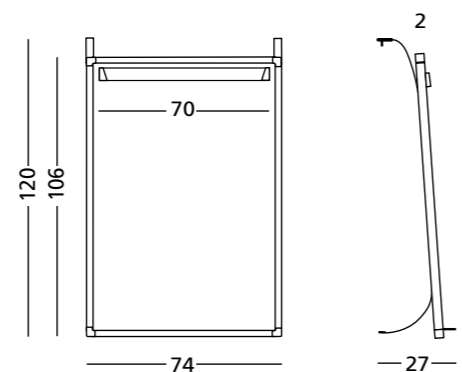

Made of wood from responsibly managed forests



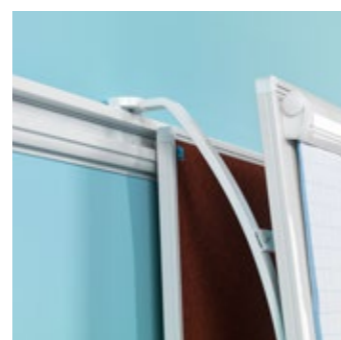

PartnerLine Rail, double



Dimensions
240 x 8 cm

Article number
12105.100

- Aluminium wall-rail system, white, 240 cm long, double version
- The boards can be hung at two different depths, enabling them to be slid in front or behind each other
- With paper clamp at the bottom edge, along the entire width of the rail
- Several rails can be joined together with the connecting piece
- Can be cut to size
- Can be mounted 'round the corner' using the the 90° corner piece (p. 149)
- Includes adapter set, paper clamp rollers, end caps, connecting piece, cover strip and mounting materials

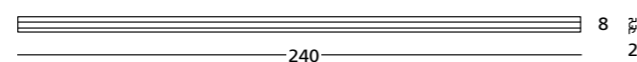

13013.101

14022.103

PartnerLine Rail, accessories



PartnerLine Rail, adapter set
Article number
13013.101

PartnerLine Rail, 90° corner piece
Article number
14022.103

- PartnerLine Rail, adapter set
- Complete set of mounting materials to hang a product in the top or bottom rail
 - Includes spacers, sliding blocks and mounting materials
 - Quick and easy to assemble

- PartnerLine Rail, 90° corner piece
- 90° corner piece for a right-angle corner joint between 2 double PartnerLine Rails

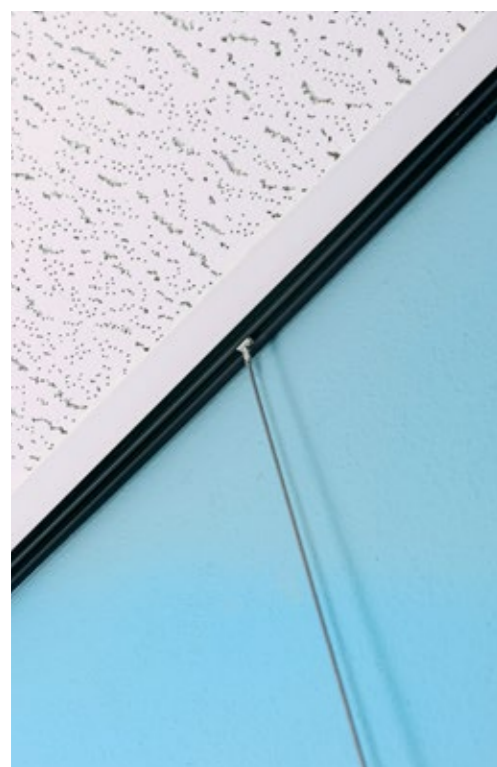

Ceiling rails



Description	Dimensions	Article number
Clip rail, ceiling mounted, white	150 x 3,5 cm	14010.102
Ceiling rail set, black	150 x 1,5 cm	14010.101

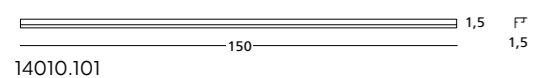
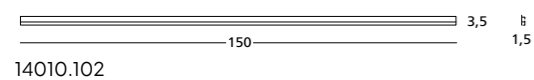

- Clip Rail set, ceiling mounted, white**
- White aluminium wall-mounted rail to hang small whiteboards and pictures
 - With space to conceal cables
 - The set consists of two 1.5 metre rails and includes suspension materials
 - Excludes whiteboard and suspension cables (suspension cables: see p. 151)

- Ceiling rail set, black**
- Black aluminium ceiling rail to hang small whiteboards and pictures
 - For mounting on the side bar of a suspended ceiling
 - The set consists of two 1.5 metre rails and includes suspension materials
 - Excludes whiteboard and suspension cables (suspension cables: see p. 151)



14010.110



14010.111



14010.112

Adapter sets



Description	Article number
Adapter set for whiteboards	14010.110
Adapter set for painting, Perlon	14010.111
Adapter set for painting, steel cable	14010.112

- Adapter set for whiteboards**
- Set for suspending whiteboards from the clip rail or ceiling rail
 - In addition to two (150 cm) steel cables and two suspension hooks, the set also includes four stabilising caps to protect the wall
 - Maximum board size 90 x 120 cm
 - Maximum weight per hook: 15 kg

- Adapter Set for Paintings, Perlon**
- Set of 2 transparent Perlon cords, 150 cm long, and two hooks to hang paintings, photos and calendars to the clip rail or ceiling rail
 - Maximum weight per hook: 4 kg

- Adapter Set for Paintings, Steel cable**
- Set of 2 steel cables, 150 cm long, and two hooks to hang paintings, photos and calendars to the clip rail or ceiling rail
 - Maximum weight per hook: 15 kg