

Whiteboards with custom print



Every organisation, department or team has its own take on specific work processes. As a result, it is rare for standard print designs to precisely match existing needs. The solution is a custom design with corporate style layout.



Logistics

Dimensions	Article number	
	Alu frame ●	Black frame ●
120 x 300 cm	11103.471	11102.280
120 x 240 cm	11103.470	11102.281
120 x 200 cm	11103.462	11102.282
120 x 180 cm	11103.461	11102.283
120 x 150 cm	11103.459	11102.284
120 x 120 cm	11103.468	11102.285
100 x 200 cm	11103.467	11102.286
100 x 150 cm	11103.458	11102.287
100 x 100 cm	11103.457	11102.288
90 x 180 cm	11103.464	11102.289
90 x 120 cm	11103.456	11102.290
60 x 90 cm	11103.453	11102.291

Softline 8 mm printed whiteboard



- Writing surface full-colour printed steel sublimation
- Suitable for normal to fairly intensive use
- Anodised or black lacquered aluminium frame with plastic corner pieces
- Includes mounting materials and 30 cm pen tray
- Can be mounted vertically or horizontally
- Magnetic, dry wipe

Made of wood from responsibly managed forests

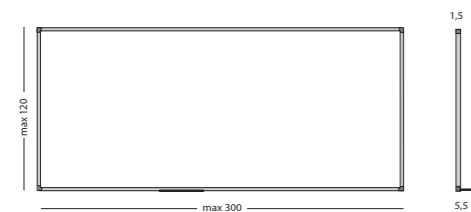

Care

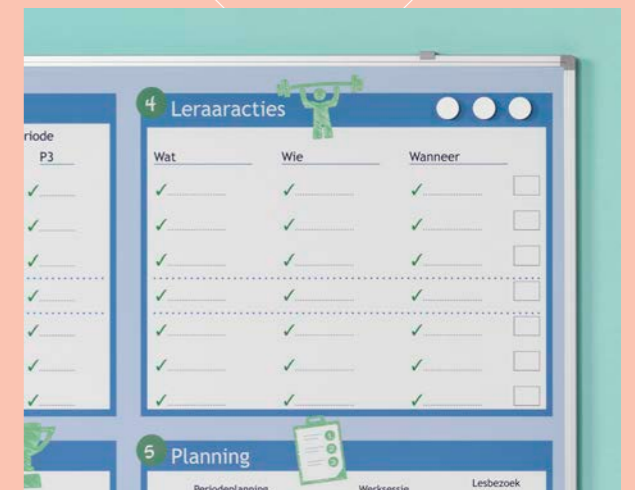

Education



Personalised designs for prints can be submitted via info@smit-visual.nl. Delivery specifications and templates can be found at www.smit-visual.com/printed-boards.

Need help with your design? Our graphics team would be more than happy to help.

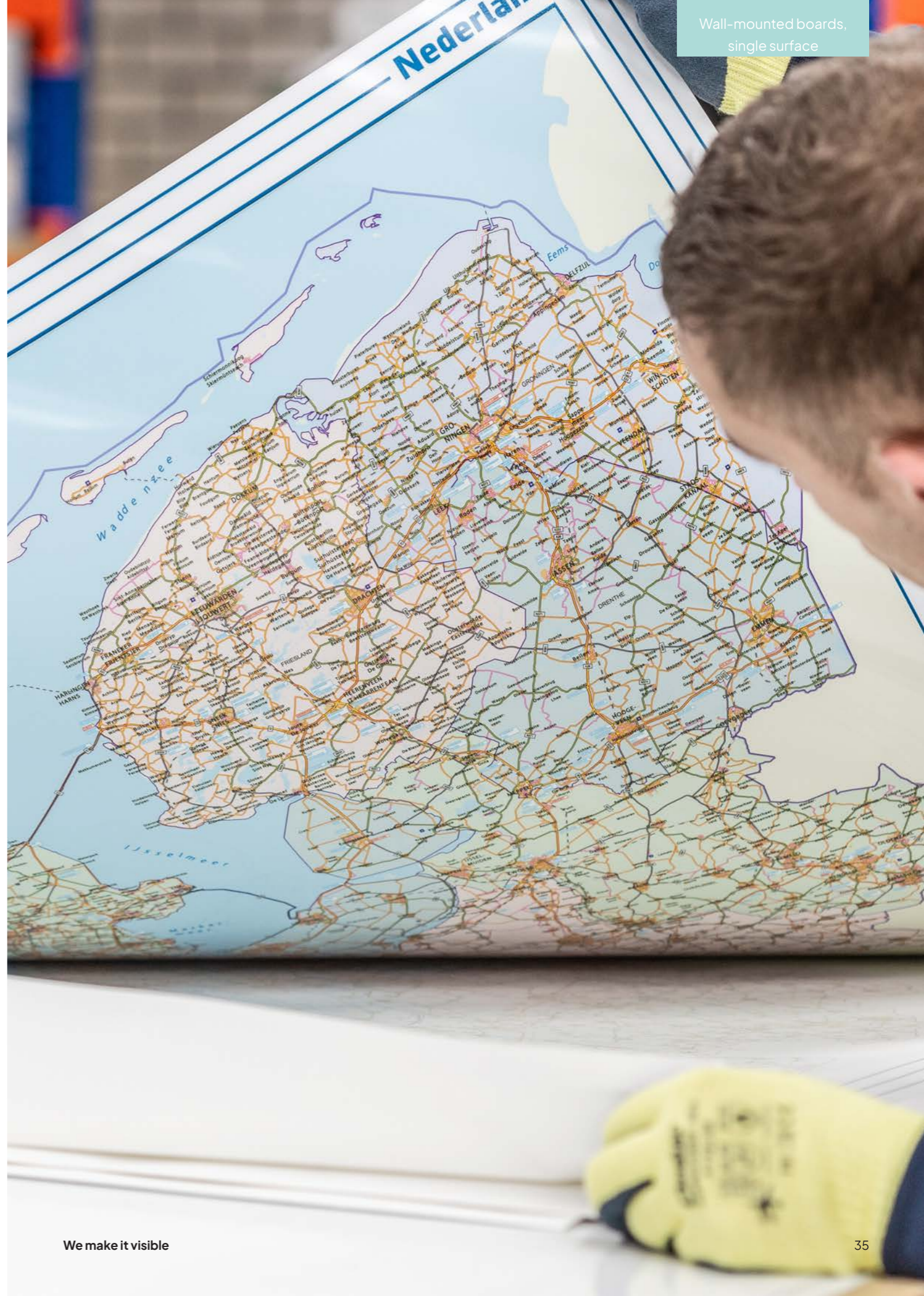

Design/Type	Dimensions - Scale	Article number
World, political	90 x 120 cm - 1: 34,232,000	11103.925
Europe, road map	90 x 120 cm - 1: 6,170,000	11103.926
The Netherlands, road map	120 x 90 cm - 1: 270,000	11103.930
The Netherlands, PC	130 x 110 cm - 1: 233,500	11103.931
BeLux, road map	110 x 130 cm - 1: 289,300	11103.932
Belgium, PC	100 x 130 cm - 1: 282,500	11103.933
Germany, road map	120 x 90 cm - 1: 771,900	11103.934
Germany, PC	120 x 90 cm - 1: 708,200	11103.935
France, road map	120 x 120 cm - 1: 170,000	11103.936
France, PC	100 x 100 cm - 1: 1,084,600	11103.937

Softline 8 mm, maps - worldwide



- Very detailed full-colour map printed on steel sublimation
- Suitable for normal to fairly intensive use
- Anodised aluminium frame with plastic corner pieces
- Includes mounting materials and 30 cm pen tray
- Magnetic, dry wipe

Accessories,
see page 220



Made of wood from responsibly managed forests

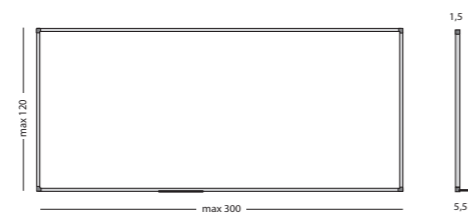

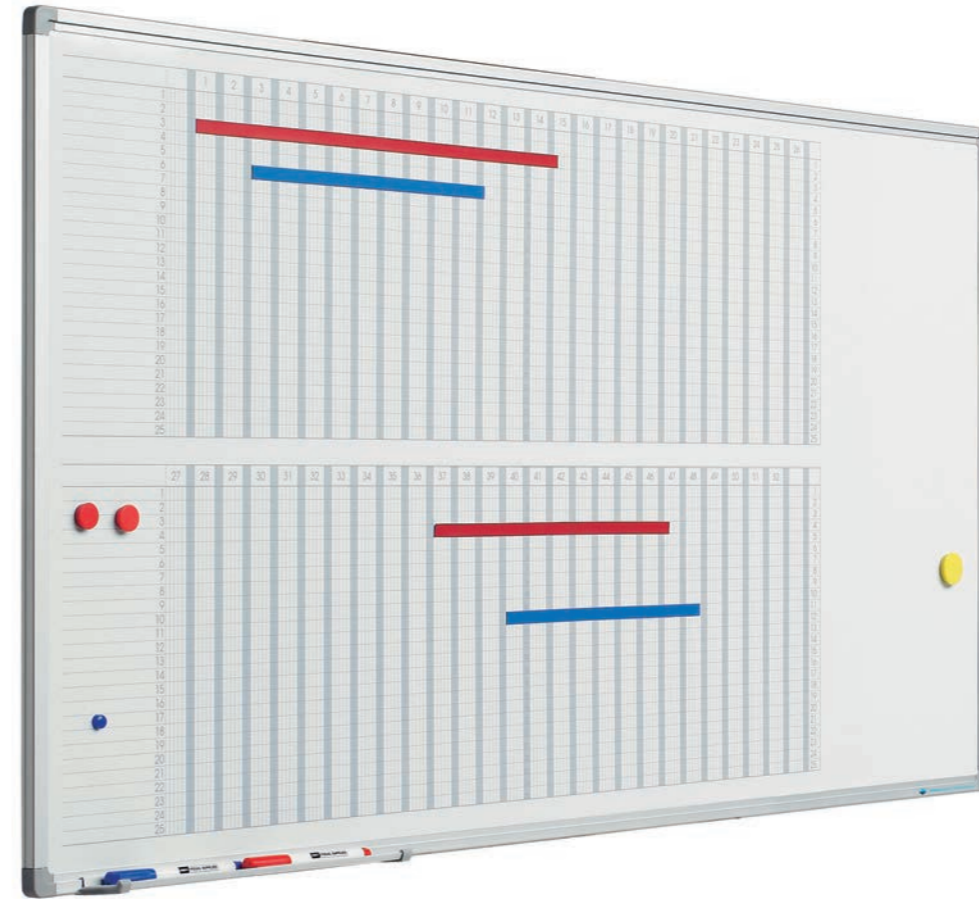

Dimensions	Language	Article number
90 x 120 cm	NL	11103.188N
90 x 120 cm	D	11103.188D
90 x 120 cm	GB	11103.188E
60 x 90 cm	NL	11103.208N
60 x 90 cm	D	11103.208D
60 x 90 cm	GB	11103.208E

Softline 8mm, double week planner



- Week planner showing two weeks beside each other and 53 free positions below each day
- Writing surface of printed steel sublimation
- Suitable for normal to fairly intensive use
- Anodised aluminium frame with plastic corner pieces
- Includes mounting materials, 30 cm pen tray and magnetic day strip for double week planner
- Magnetic, dry wipe

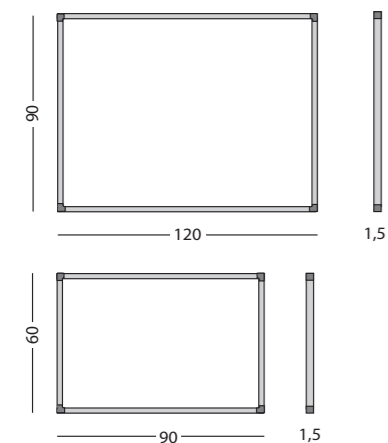
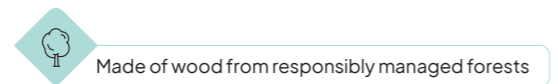

Dimensions	Article number
60 x 120 cm	11103.198

Softline 8mm, 53-week planner



- Planner with space for 53 weeks horizontally
- 25 free positions per week, vertically
- Writing surface of printed steel sublimation
- Suitable for normal to fairly intensive use
- Anodised aluminium frame with plastic corner pieces
- Includes mounting materials and 30 cm pen tray
- Magnetic, dry wipe

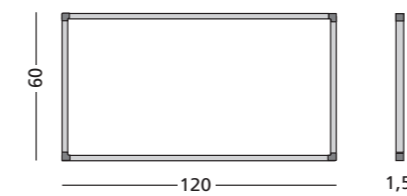
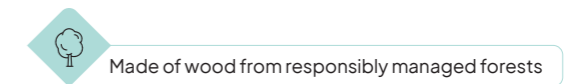

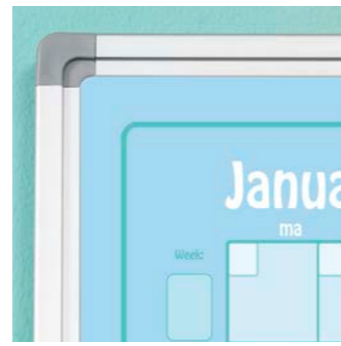
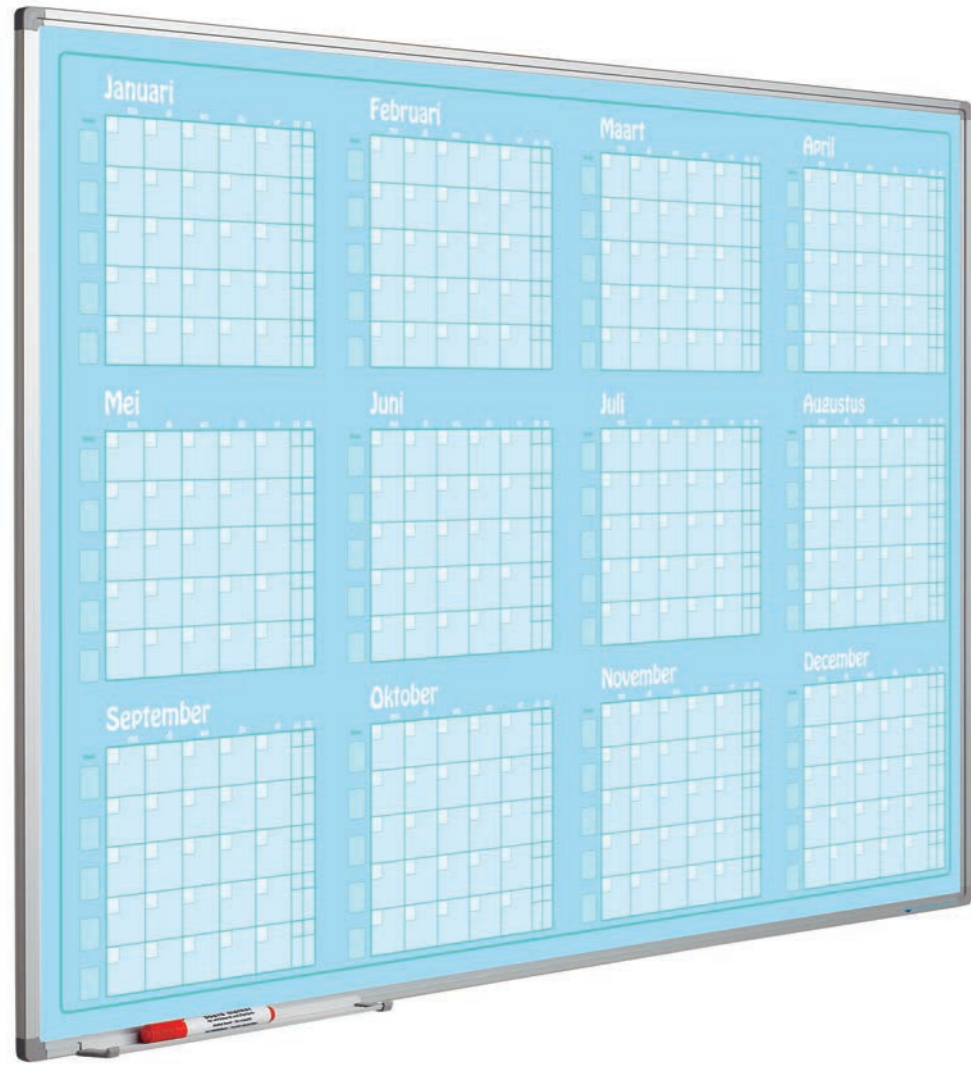

Dutch



English



German

Dimensions	Period	Language	Article number
90 x 120 cm	Jan - Dec	NL	11103.574
90 x 120 cm	Jan - Dec	D	11103.575
90 x 120 cm	Jan - Dec	GB	11103.576
90 x 120 cm	Aug - Jul	NL	11103.577
90 x 120 cm	Aug - Jul	D	11103.578
90 x 120 cm	Aug - Jul	GB	11103.579
Customisation			
90 x 120 cm	Period	Language	11103.999

Softline 8mm year planner, blue



- Continuous year planner pre-printed with 12 months (January - December or August - July)
- Every month has space for 53 weeks
- Weeks and dates can be filled in as required
- Writing surface full-colour printed steel sublimation
- Suitable for normal to fairly intensive use
- Anodised aluminium frame with plastic corner pieces
- Includes mounting materials and 30 cm pen tray
- Magnetic, dry wipe

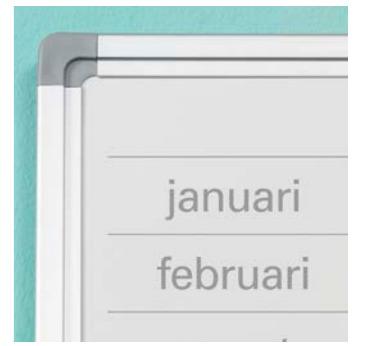
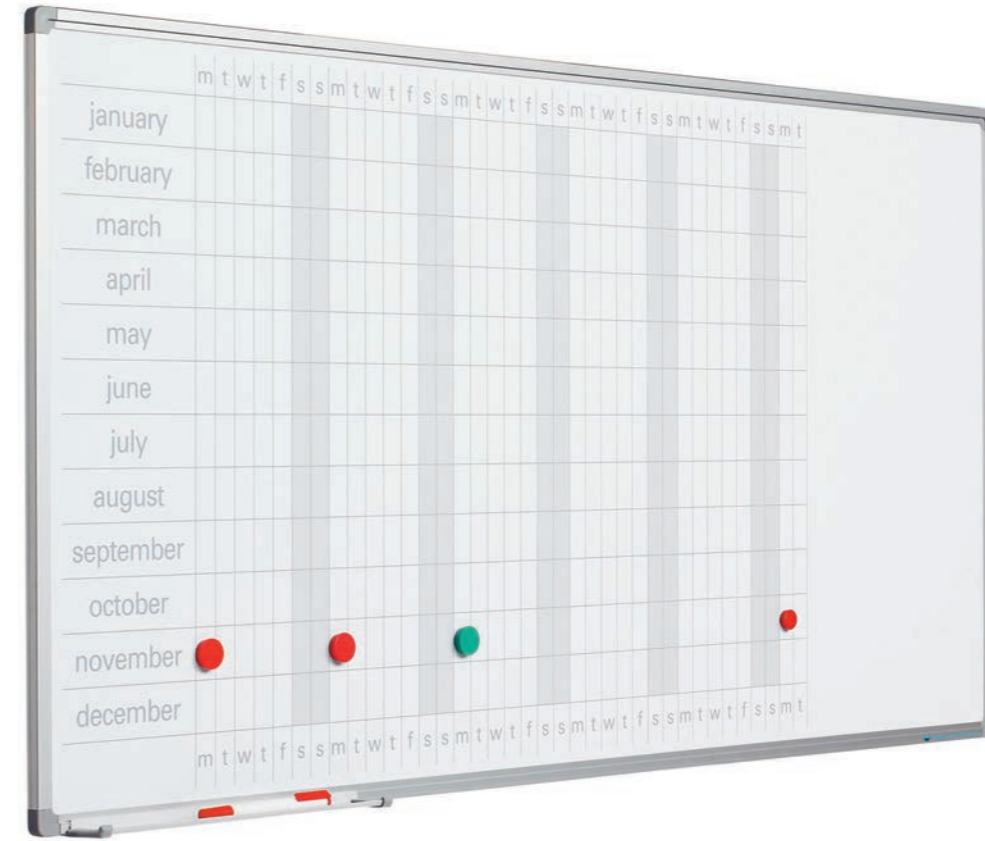
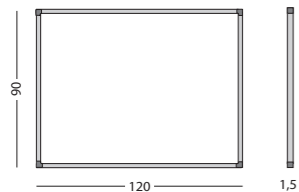
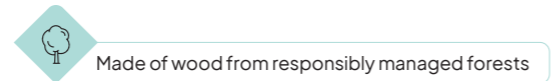

Dutch

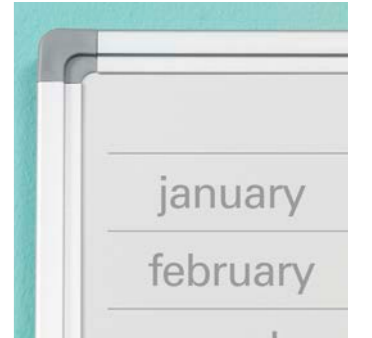

English

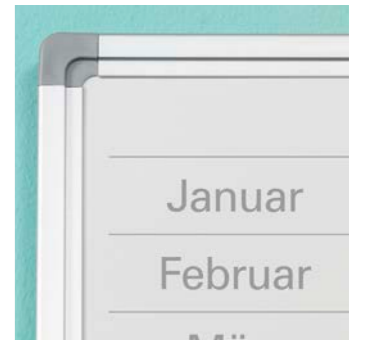

German

Dimensions	Language	Article number
60 x 120 cm	NL	11103.196N
60 x 120 cm	D	11103.282D
60 x 120 cm	GB	11103.281E

Set of extra horizontal day strips (12 strips): 14035.130

Softline 8mm year planner



- Preprinted, showing the months vertically and the days horizontally
- Writing surface of printed steel sublimation
- Suitable for normal to fairly intensive use
- Anodised aluminium frame with plastic corner pieces
- Includes mounting materials, 30 cm pen tray and (12) magnetic horizontal day strips
- Magnetic, dry wipe

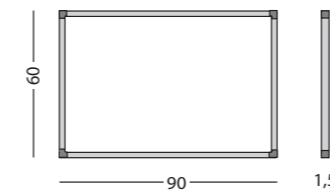
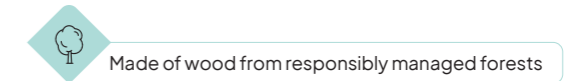

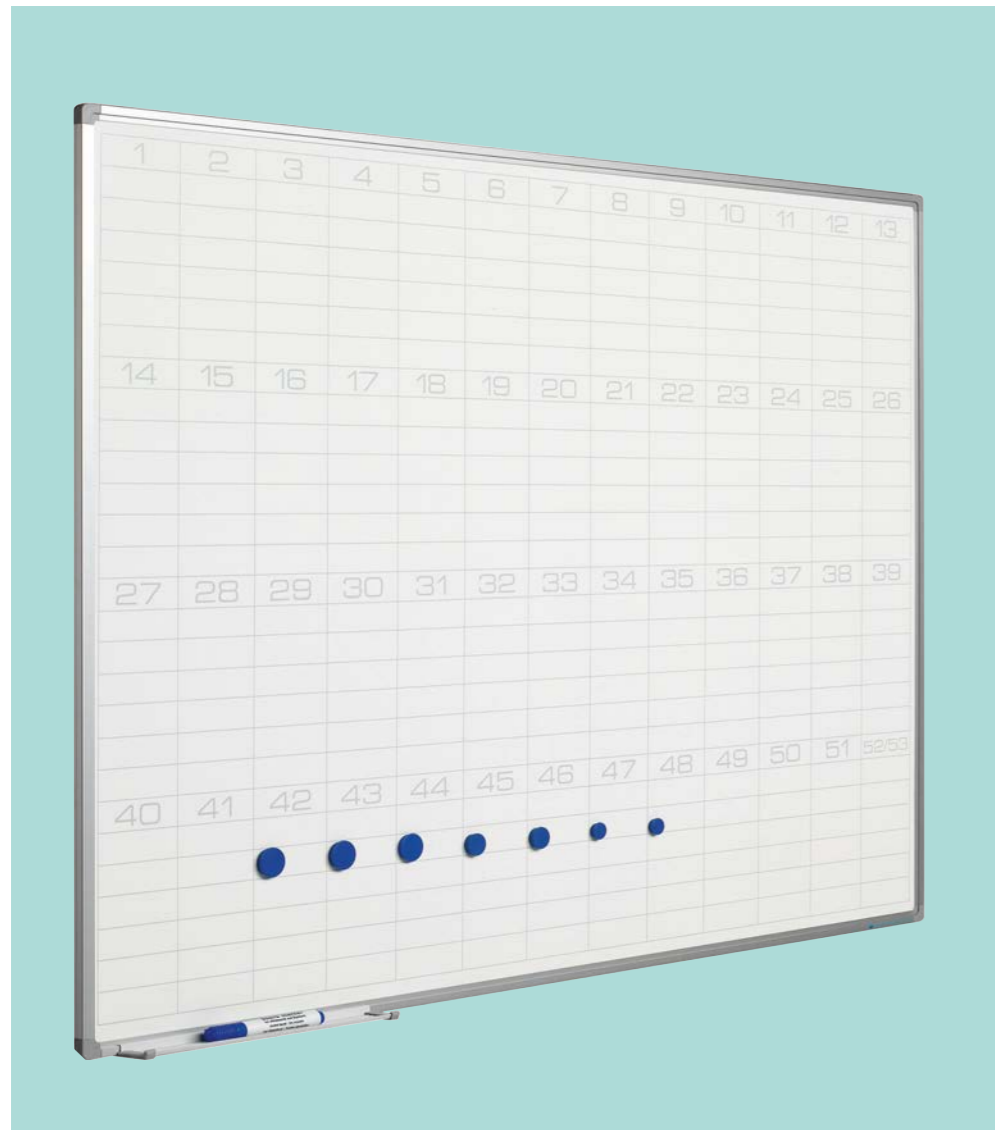

Dimensions
90 x 120 cm
60 x 90 cm

Article number
11103.187
11103.207

Softline 8mm yearly overview planner



- Horizontally preprinted with 53 weeks
- 6 free spaces below each week
- Writing surface of printed steel sublimation
- Suitable for normal to fairly intensive use
- Anodised aluminium frame with plastic corner pieces
- Includes mounting materials and 30 cm pen tray
- Magnetic, dry wipe

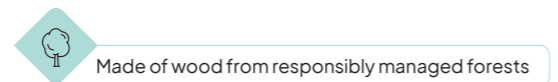
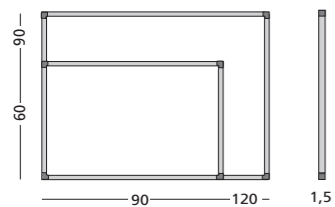

Dimensions
90 x 120 cm
90 x 120 cm
90 x 120 cm

Language
NL
D
GB

Article number
11103.186N
11103.186D
11103.186E

60 x 90 cm
60 x 90 cm
60 x 90 cm

NL
D
GB

11103.206N
11103.206D
11103.206E

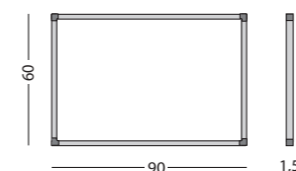
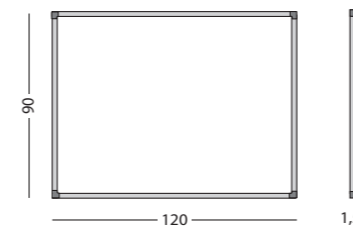

Softline 8mm vertical year planner



- Continuous year planner
- The months, days and dates can be shown for each year with the aid of magnetic strips
- Writing surface of printed steel sublimation
- Suitable for normal to fairly intensive use
- Anodised aluminium frame with plastic corner pieces
- Includes mounting materials, 30 cm pen tray and vertical number strips, horizontal strip indicating the month and vertical strip indicating the day. (all strips are magnetic)
- Magnetic, dry wipe

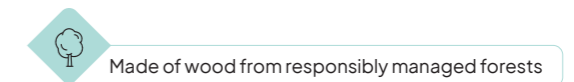

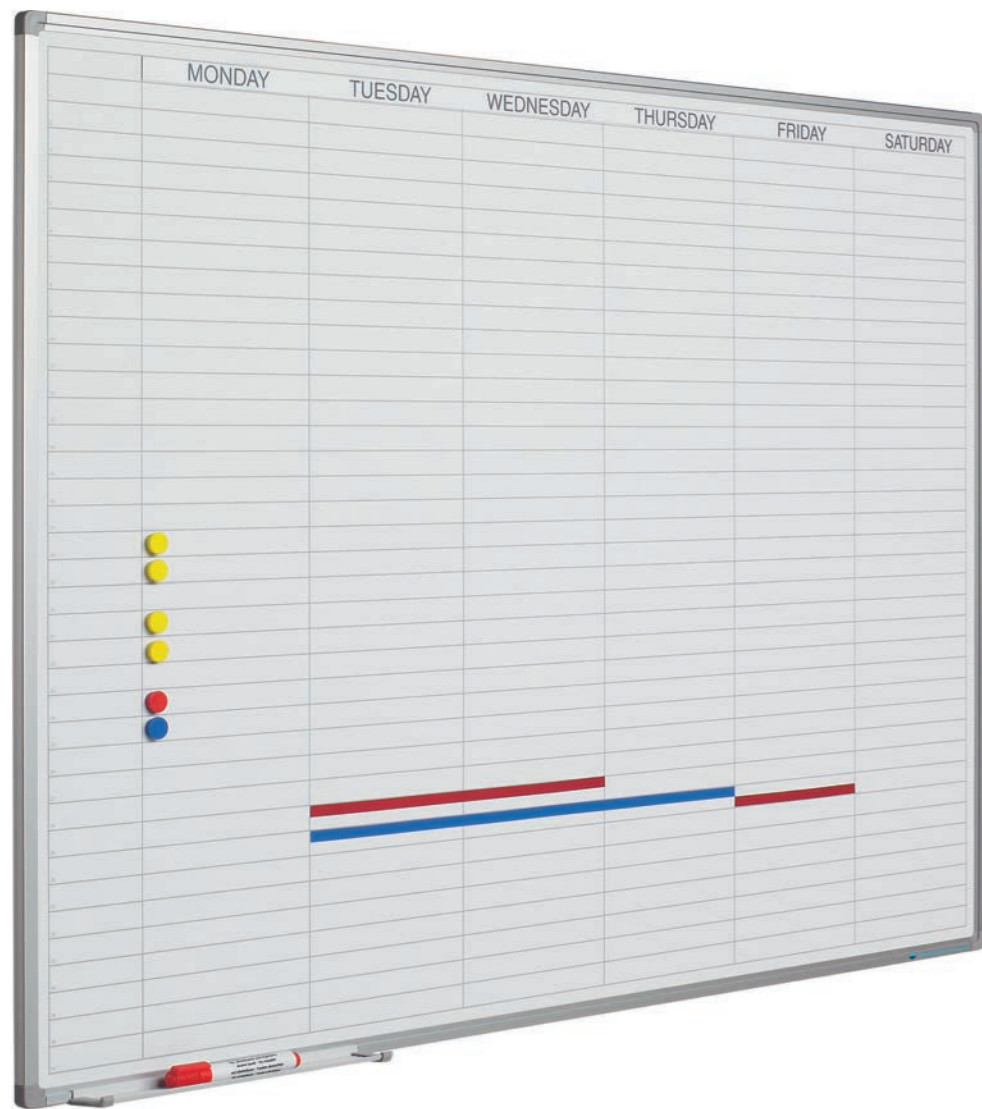

Dutch



English



German

Dimensions	Language	Article number
90 x 120 cm	NL	11103.185N
90 x 120 cm	GB	11103.185E
90 x 120 cm	D	11103.185D
60 x 90 cm	NL	11103.205N
60 x 90 cm	GB	11103.205E
60 x 90 cm	D	11103.205D

Softline 8mm working days planner



- Workday planner showing Monday to Saturday horizontally with 37 free spaces below each day
- Writing surface of printed steel sublimation
- Suitable for normal to fairly intensive use
- Anodised aluminium frame with plastic corner pieces
- Includes mounting materials, 30 cm pen tray and (12) magnetic horizontal day strips
- Magnetic, dry wipe

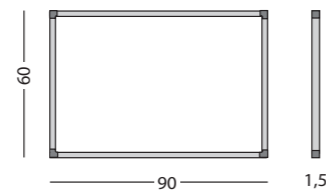

Made of wood from responsibly managed forests

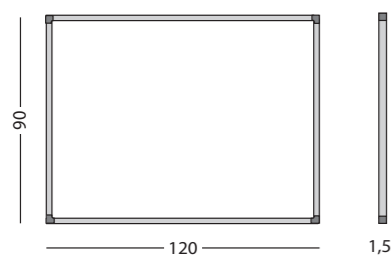

Dimensions	Language	Article number
60 x 120 cm	NL	11103.195
60 x 120 cm	D	11103.277
60 x 120 cm	GB	11103.276
Week numbers (set of 52)		14035.125

Softline 8mm, weekly planner



- Preprinted showing weekdays horizontally and 5 rows of weeks vertically
- This board can also be used as a month planner by numbering the spaces from 1 to 31
- Writing surface of printed steel sublimation
- Suitable for normal to fairly intensive use
- Anodised aluminium frame with plastic corner pieces
- Includes mounting materials and 30 cm pen tray
- Magnetic, dry wipe

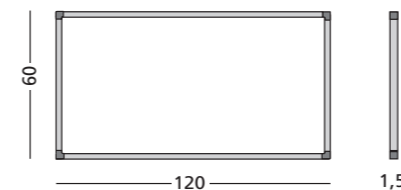

Made of wood from responsibly managed forests

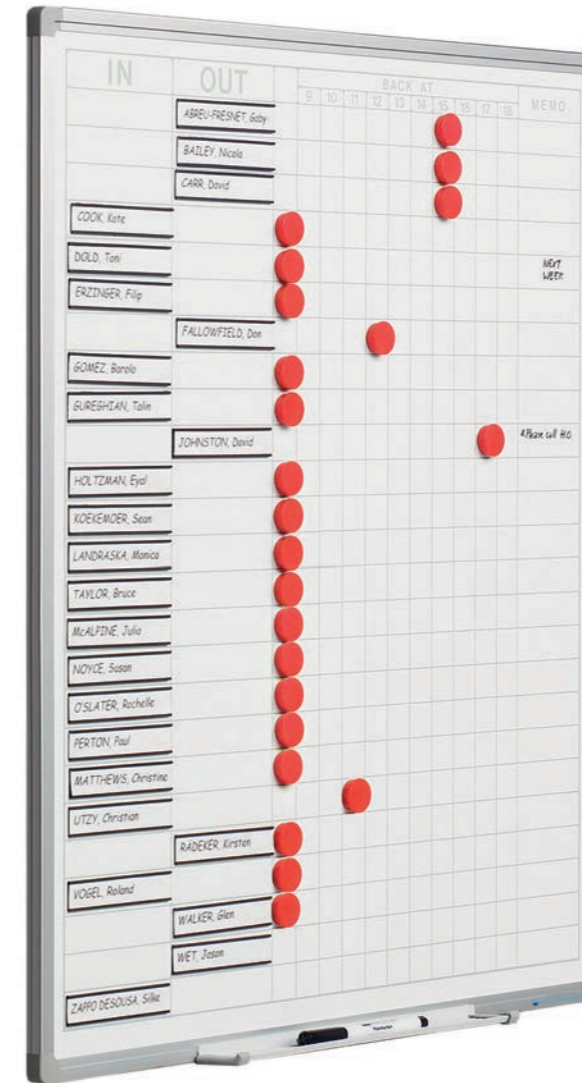
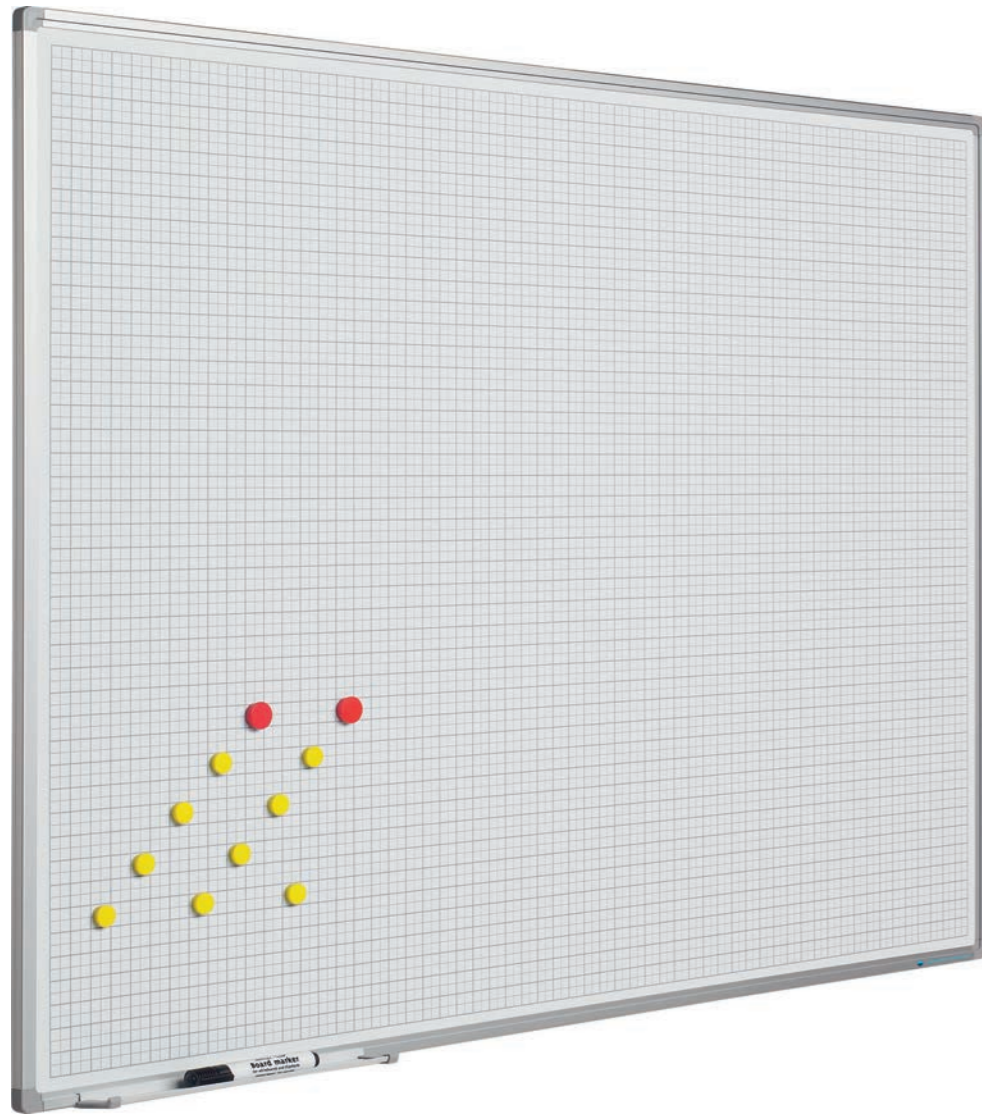

Dimensions	Square size	Article number
100 x 200 cm	5 x 5 cm	11103.143
120 x 200 cm	5 x 5 cm	11103.144
90 x 120 cm	5 x 5 cm	11103.141
90 x 120 cm	2 x 2 cm (1 x 1 cm)	11103.146

Softline 8mm squared boards



- Squared pattern of 5x5 cm preprinted on enamel, suitable for very intensive and long-term use
- Squared pattern of 2x2 cm preprinted on steel sublimation, suitable for normal to fairly intensive use
- Anodised aluminium frame with plastic corner pieces
- Includes mounting materials and 30 cm pen tray
- Magnetic, dry wipe

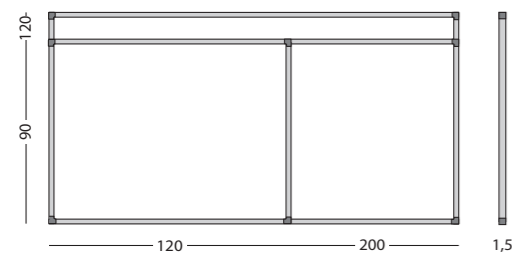
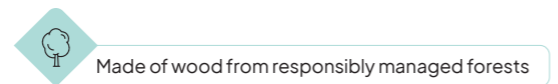

Dimensions	Article number
70 x 60 cm	11103.215

Softline 8mm In-Out board



- Space for 25 names
- Writing surface of printed steel sublimation
- Suitable for normal to fairly intensive use
- Anodised aluminium frame with plastic corner pieces
- Includes mounting materials, 30 cm pen tray, 25 red magnets (Ø 25 mm) and 25 magnetic name holders (2 x 10 cm)
- Magnetic, dry wipe

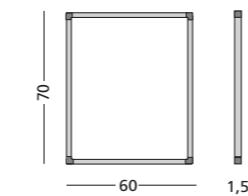
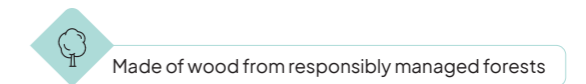

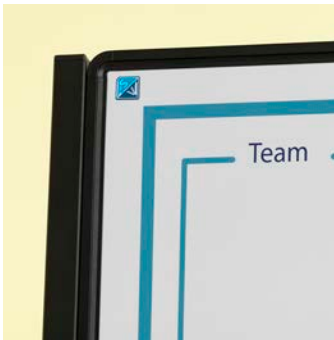

Dimensions
120 x 150 cm
120 x 75 cm

Article number
13019.040
13019.041

Work Board, printed



More info on
customised printing?

See page 29

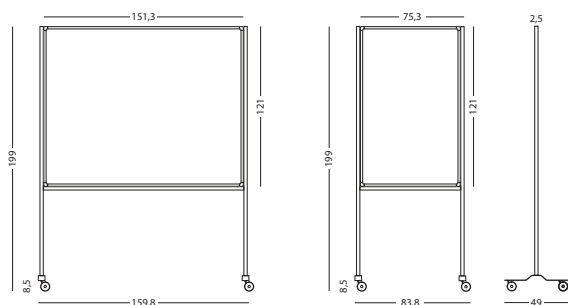

- Writing surface of double-sided, full-colour printed steel sublimation
- Suitable for normal to fairly intensive use
- Black aluminium frame with plastic corner pieces
- Stable black steel frame
- Four high-quality wheels, two of which have brakes
- Multiple boards can be wheeled together compactly for storage
- The arch in the foot enables you to wheel together at right angles to create corner presentations.
- Magnetic, dry wipe



Made of wood from responsibly managed forests

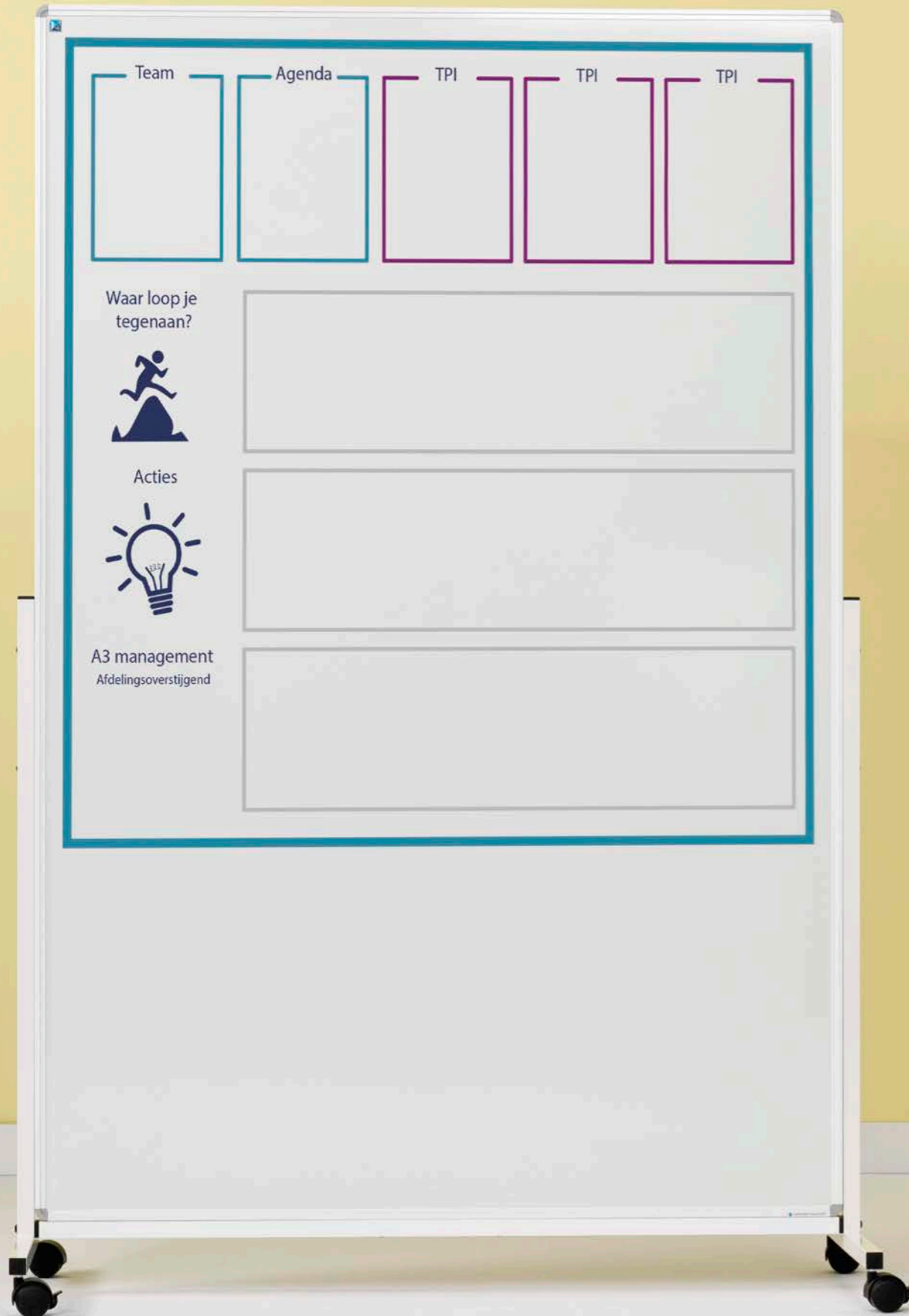

More info on customised printing?
See page 33

Dimensions
180 x 75 cm
180 x 120 cm

Article number
13018.230
13018.231

Smit Visual Mobile Whiteboard, printed



- Writing surface of double-sided, full-colour printed steel sublimation
- Suitable for normal to fairly intensive use
- White aluminium frame with plastic corner pieces
- The simple design makes the unit both sturdy and lightweight.
- Four castor wheels, two of which have brakes.
- Magnetic, dry wipe

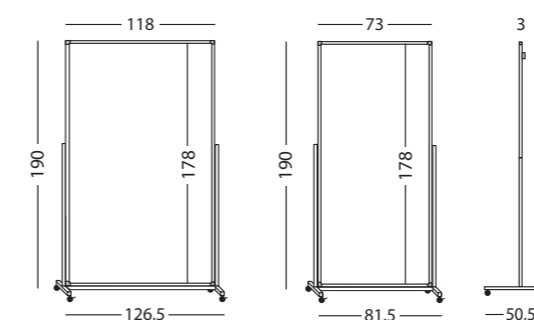

 Made of wood from responsibly managed forests

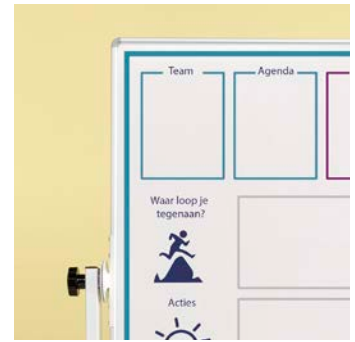

Dimensions	Article number
120 x 200 cm	13009.204
120 x 180 cm	13009.206
120 x 150 cm	13009.205
100 x 200 cm	13009.200
100 x 180 cm	13009.201
100 x 150 cm	13009.202
90 x 120 cm	13009.203

Revolving whiteboard, printed

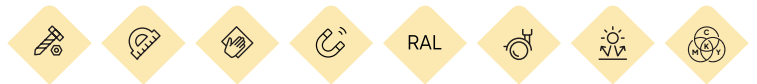

More info on customised printing?

See page 29

- Writing surface of double-sided, full-colour printed steel sublimation
- Suitable for normal to fairly intensive use
- Anodised aluminium frame with plastic corner pieces
- The sturdy white base has a long pen tray and four solid industrial wheels, two of which have brakes
- The rotary knob allows the board to be turned through 360° and to be fixed at any angle
- Magnetic, dry wipe

